

**HTC**  
Via degli Elettricisti - Zona Industriale  
64020 Sceme di Pineto (TE)  
Tel.: +390859463008 Fax:+390859462461  
www.htc-cnc.com e-mail: htc@cnc.com

DISGNATO F.A.	DATA 2017	REV. 2	SCALA: 1:1
CODICE COMPLESSIVO	QUANTITA' PER MACCHINA:	DESCRIZIONE	
	POWER IP UP45-N	5200 SS	

IL PRESENTE DOCUMENTO E' PROPRIETA' DELLA HTC SRL E NON PUO' ESSERE RIPRODOTTO E PORTATO A CONOSCENZA DI TERZI SENZA L'AUTORIZZAZIONE SCRITTA  
This document is a property of HTC Srl and it cannot be reproduced or send to oth

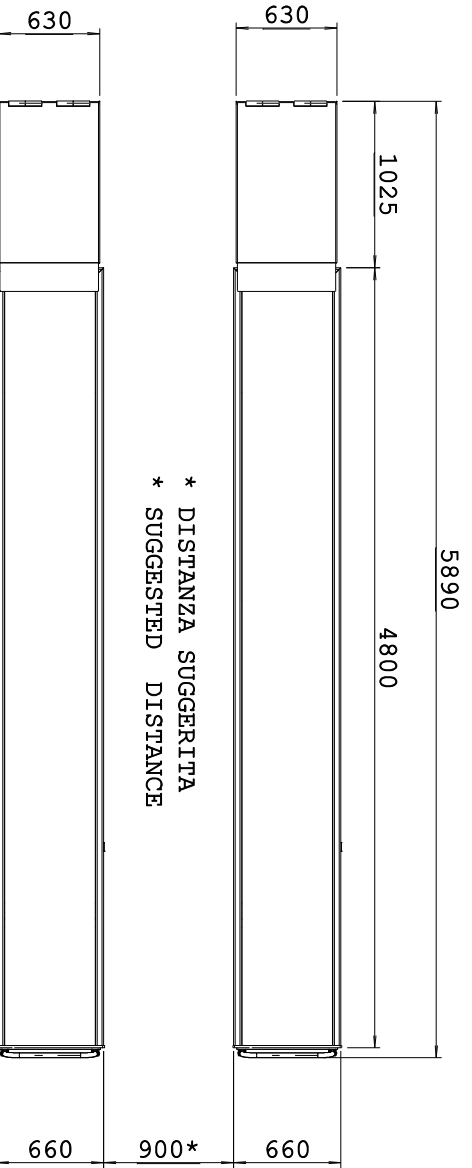
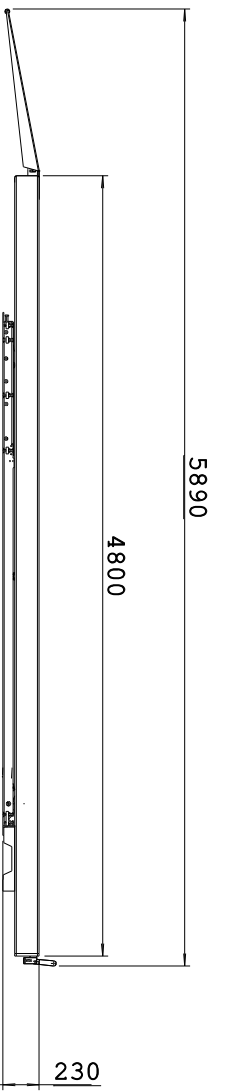
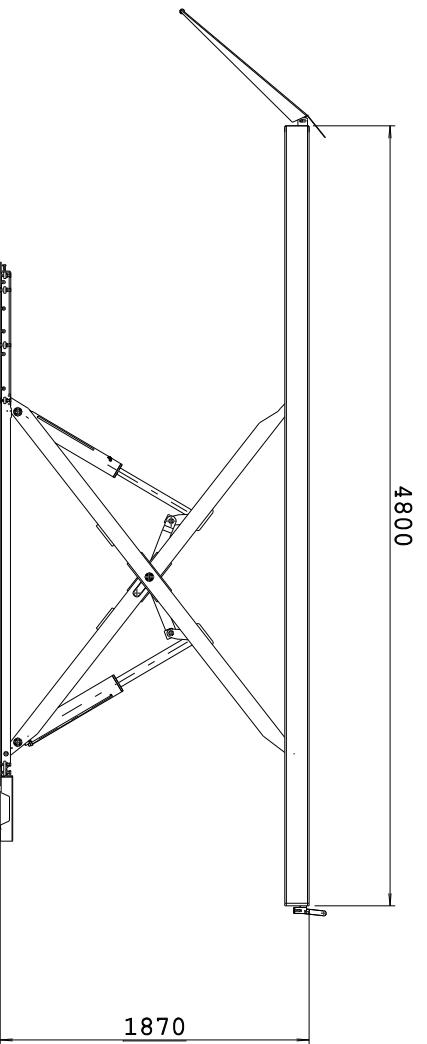

**HTC**  
 Via degli Elettricisti - Zona Industriale  
 64020 Sceme di Pineto (TE)  
 Tel.: +390859463008 Fax:+390859462461  
 www.htc-cnc.com e-mail: htc@htc-cnc.com

DISEGNATO F.A.	DATA 2017	REV. 2	SCALA: 1:1
CODICE COMPLESSIVO	QUANTITA' PER MACCHINA:	DESCRIZIONE	
	POWER LP UP45-N	4800 SS	

IL PRESENTE DOCUMENTO E' PROPRIETA' DELLA HTC SRL E NON PUO' ESSERE RIPRODOTTO E PORTATO A CONOSCENZA DI TERZI SENZA L'AUTORIZZAZIONE SCRITTA  
 This document is a property of HTC Srl and it cannot be reproduced or send to oth

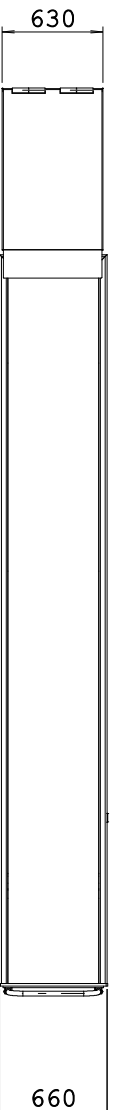
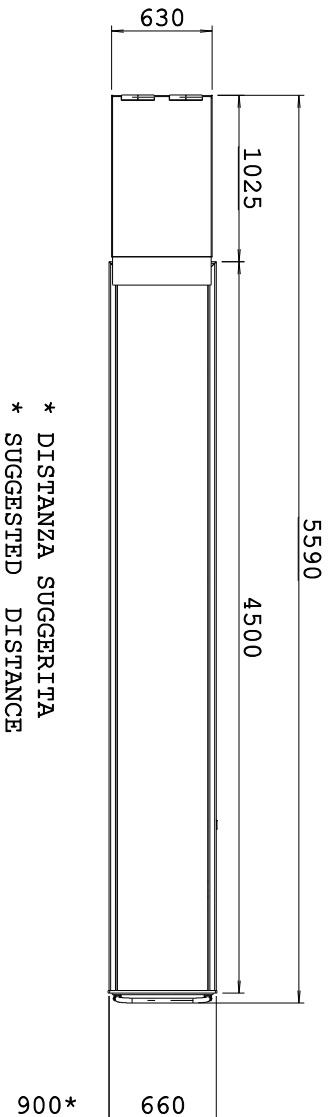
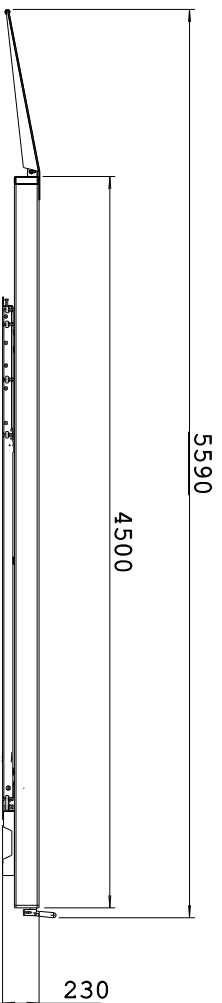
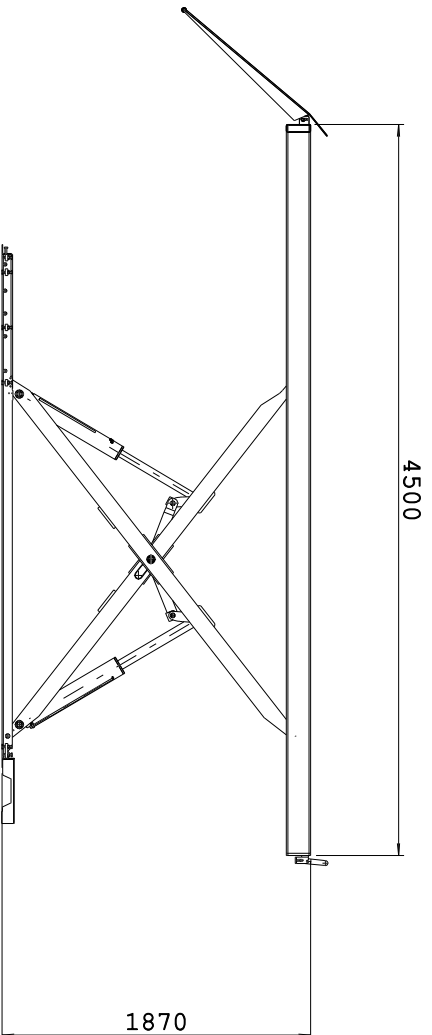

\* DISTANZA SUGGERITA  
\* SUGGESTED DISTANCE

**HTC**  
Via degli Elettricisti - Zona Industriale  
64020 Sceme di Pineto (TE)  
Tel.: +390859463008 Fax:+390859462461  
www.htc-cnc.com e-mail: htc@htc-cnc.com

DISGNATO F.A.	DATA 2017	REV. 2	SCALA: 1:1
CODICE COMPLESSIVO	QUANTITA' PER MACCHINA:	DESCRIZIONE	
	POWER LP UP45-N	4500 SS	

IL PRESENTE DOCUMENTO E' PROPRIETA' DELLA HTC SRL E NON PUO' ESSERE RIPRODOTTO E PORTATO A CONOSCENZA DI TERZI SENZA L'AUTORIZZAZIONE SCRITTA  
This document is a property of HTC Srl and it cannot be reproduced or send to oth

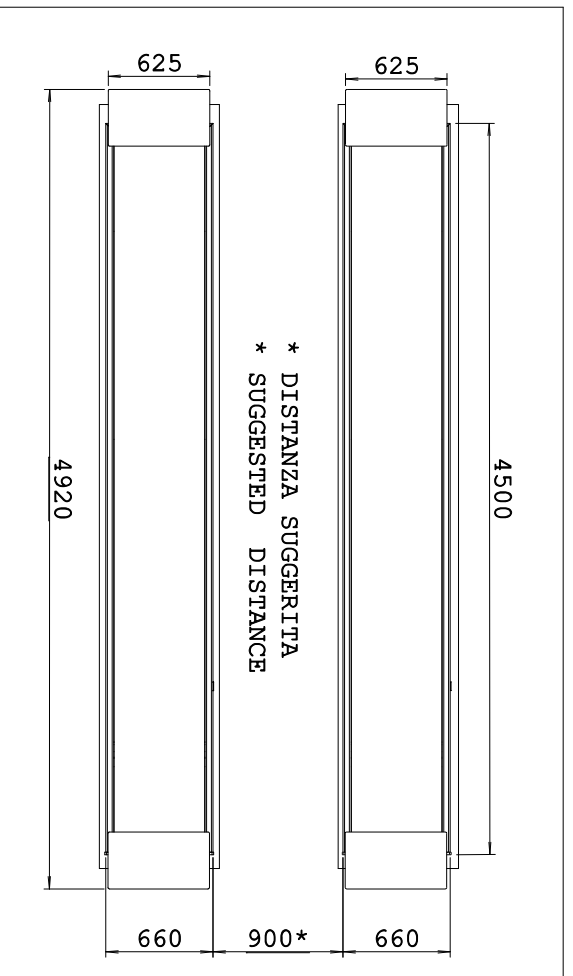
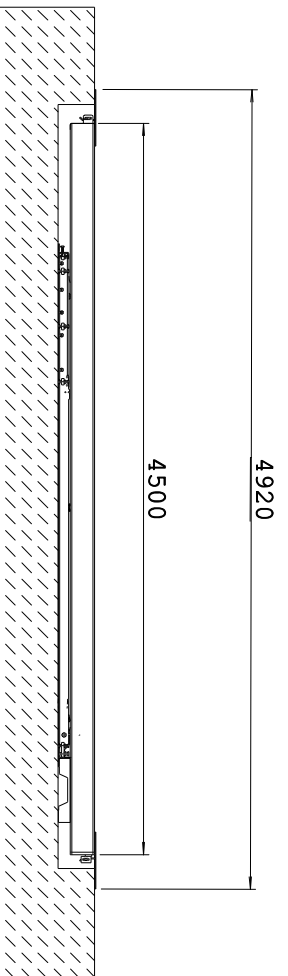
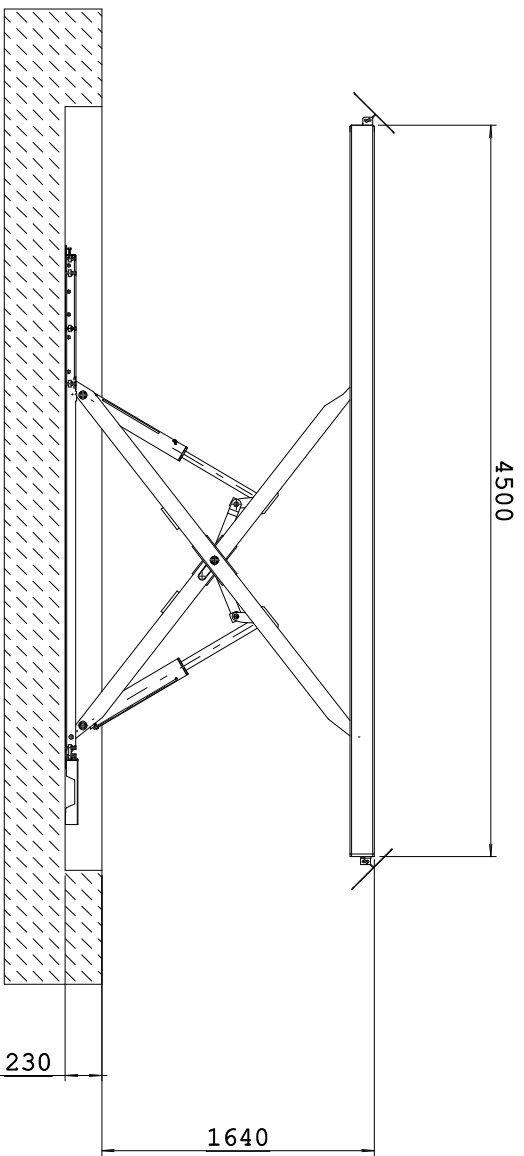

# HTC

Via degli Elettricisti - Zona Industriale  
64020 Sceme di Pineto (TE)  
Tel.: +390859463008 Fax: +390859462461  
www.htc-cnc.com e-mail: htc@htc-cnc.com

DISEGNATO F.A.	DATA 2017	REV. 2	
CODICE COMPLESSIVO	QUANTITA' PER MACCHINA:	DESCRIZIONE	SCALA: 1:1
	POWER LP UP45-N	4500 I	

IL PRESENTE DOCUMENTO E' PROPRIETA' DELLA HTC SRL E NON PUO' ESSERE RIPRODOTTO E PORTATO A CONOSCENZA DI TERZI SENZA L'AUTORIZZAZIONE SCRITTA  
This document is a property of HTC Srl and it cannot be reproduced or send to oth

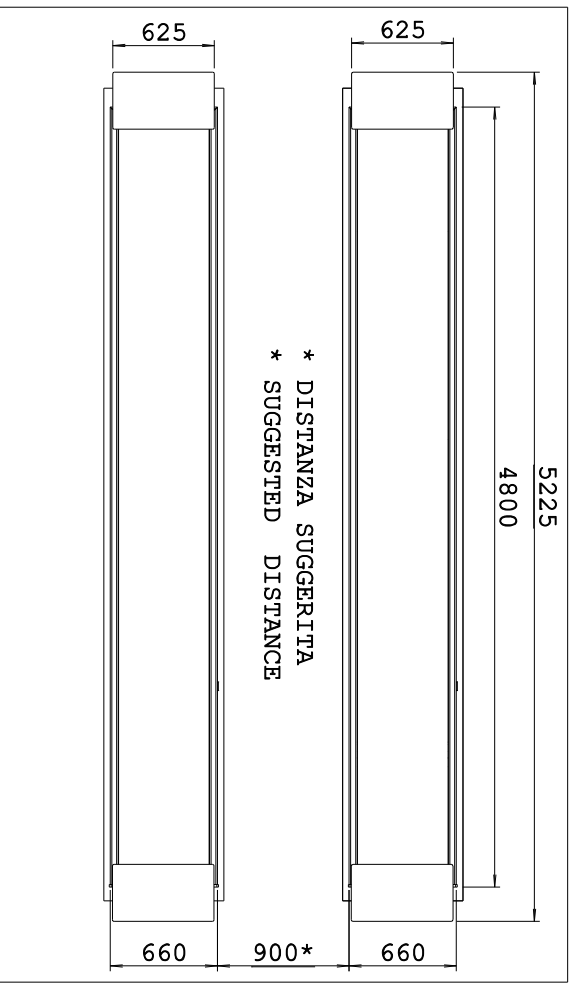
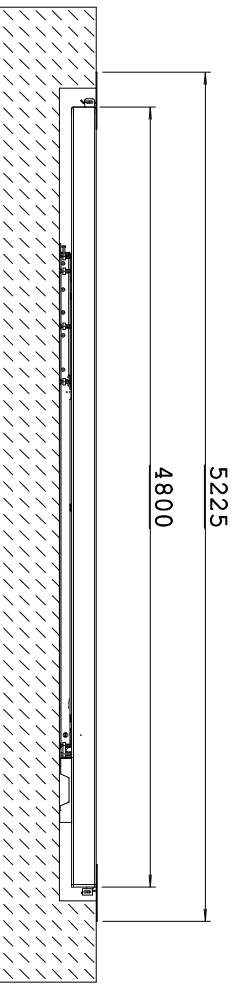
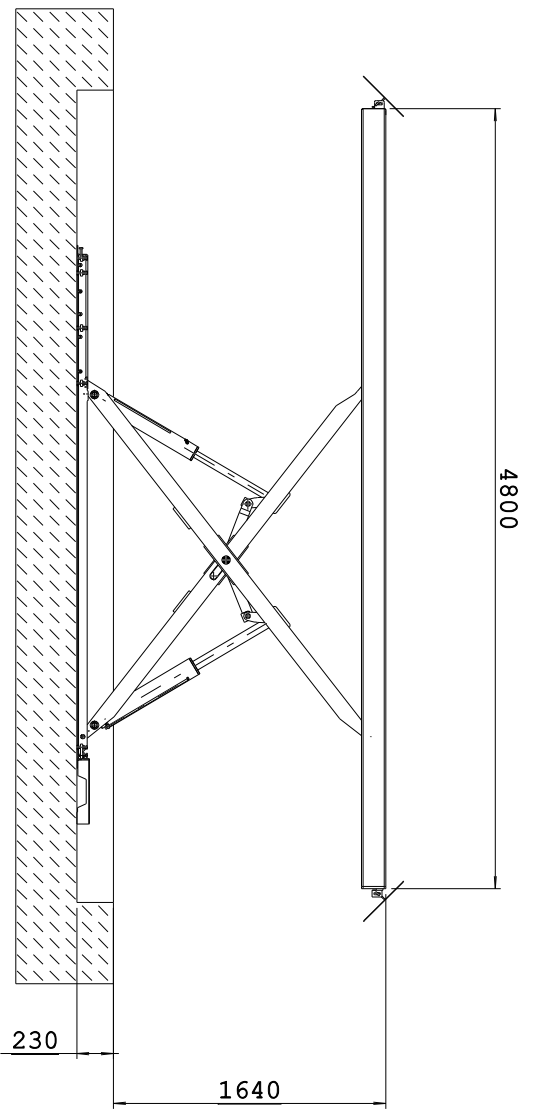

<b>HTC</b> Via degli Elettricisti - Zona Industriale 64020 Sceme di Pineto (TE) Tel.: +390859463008 Fax:+390859462461 www.htc-cnc.com e-mail: htc@htc-cnc.com		DISEGNATO F.A.	DATA 2017	REV. 2	SCALA: 1:1
CODICE COMPLESSIVO	QUANTITA' PER MACCHINA: DESCRIZIONE	POWER LP UP45-N 4800 I			

IL PRESENTE DOCUMENTO E' PROPRIETA' DELLA HTC SRL E NON PUO' ESSERE RIPRODOTTO E PORTATO A CONOSCENZA DI TERZI SENZA L'AUTORIZZAZIONE SCRITTA  
 This document is a property of HTC Srl and it cannot be reproduced or send to ot

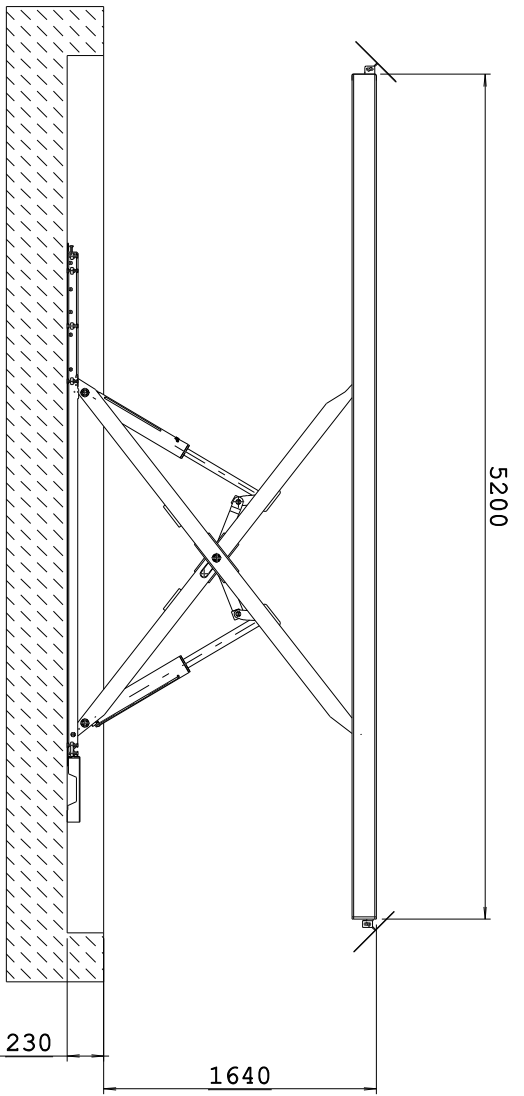

Sez. F - F

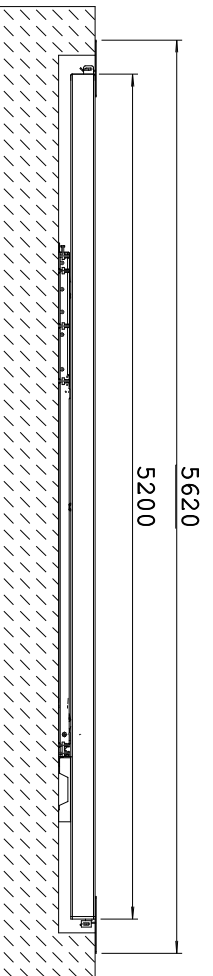

Sez. E - E

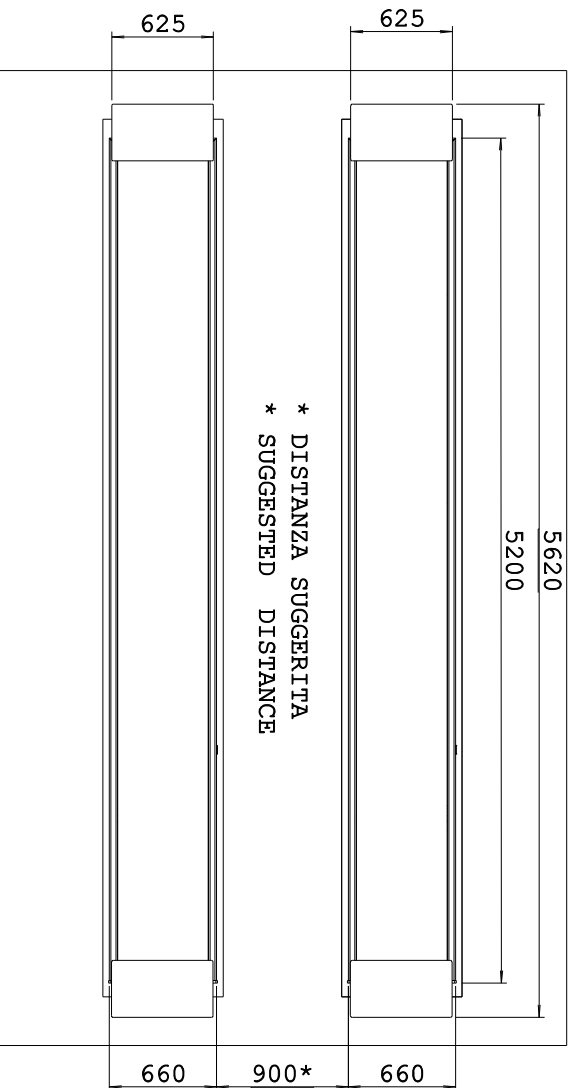

\* DISTANZA SUGGERITA  
\* SUGGESTED DISTANCE

# HTC

Via degli Elettricisti - Zona Industriale  
64020 Sceme di Pineto (TE)  
Tel.: +390859463008 Fax:+390859462461  
www.htc-cnc.com e-mail: htc@htc-cnc.com

DISEGNATO F.A.	DATA 2017	REV. 2	SCALA: 1:1
CODICE COMPLESSIVO	QUANTITA' PER MACCHINA:	DESCRIZIONE	
	POWER LP UP45-N 5200 I		

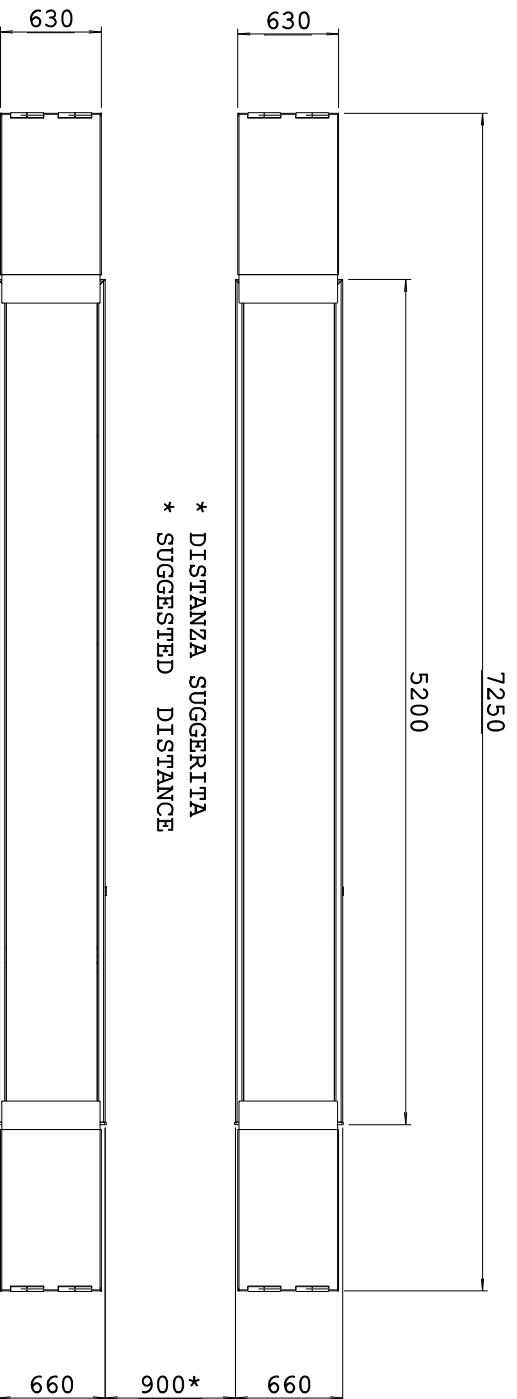
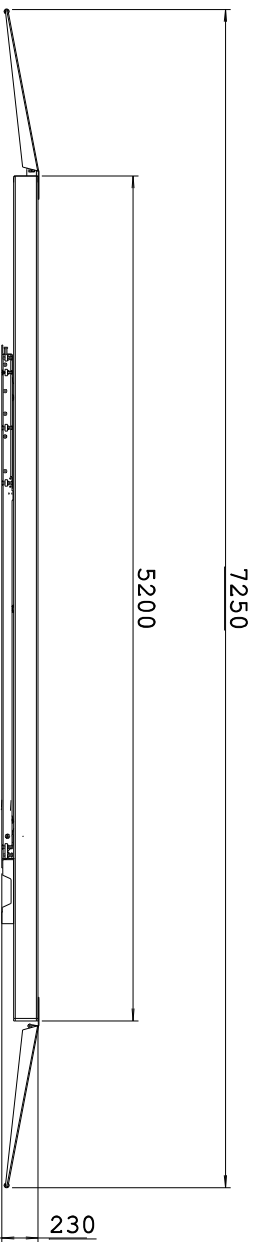
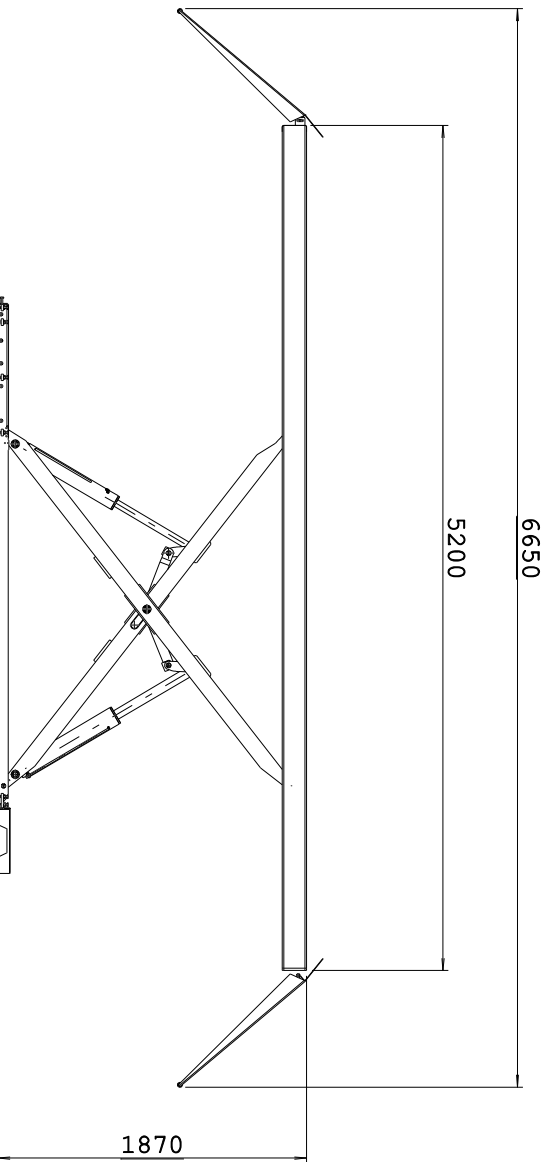

\* DISTANZA SUGGERITA  
 \* SUGGESTED DISTANCE

900\*

660

# HTC

Via degli Elettricisti - Zona Industriale  
 64020 Scame di Pineto (TE)  
 Tel.: +390859463008 Fax:+390859462461  
 www.htc-cnc.com e-mail: htc@htc-cnc.com

DISEGNATO F.A.	DATA	REV.	DESCRIZIONE
CODICE COMPLESSIVO	2017	2	POWER LP UP45-N 5200 SD

IL PRESENTE DOCUMENTO E' PROPRIETA' DELLA HTC SRL E NON PUO' ESSERE RIPRODOTTO E PORTATO A CONOSCENZA DI TERZI SENZA L'AUTORIZZAZIONE SCRITTA  
 This document is a property of HTC Srl and it cannot be reproduced or send to of

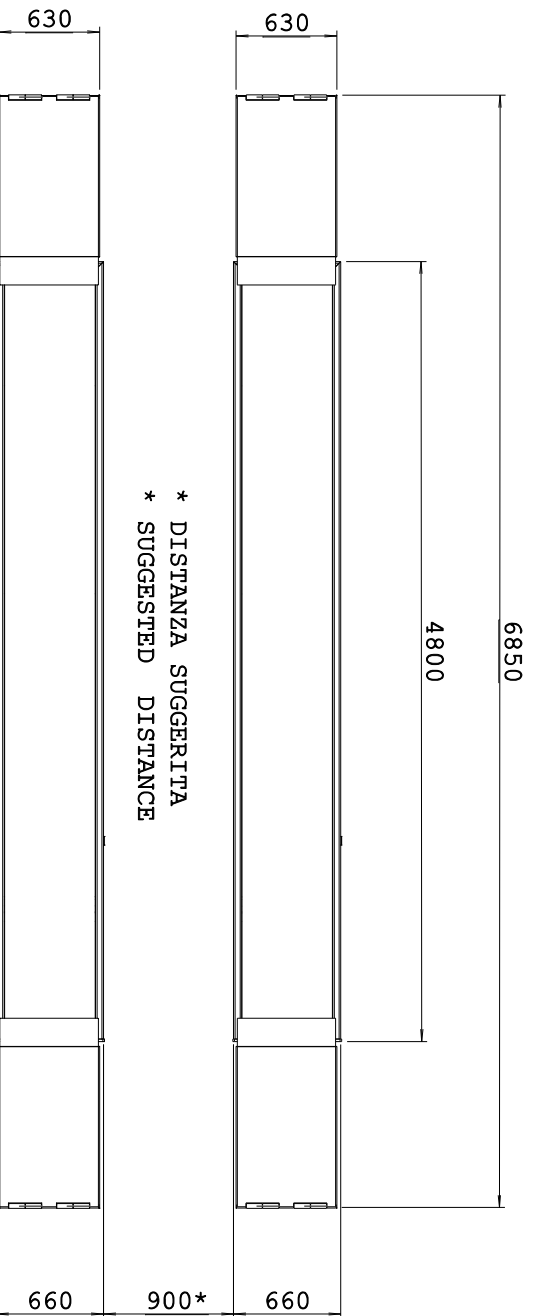
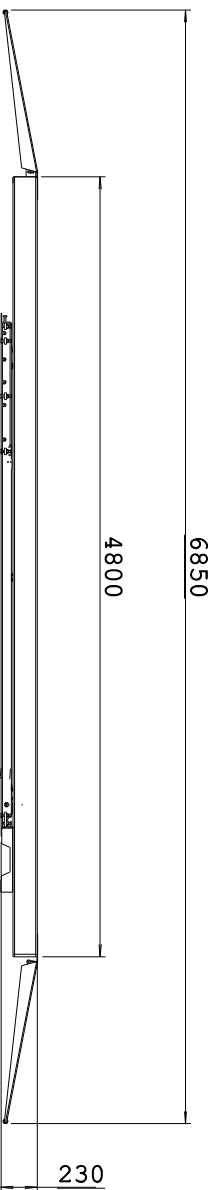
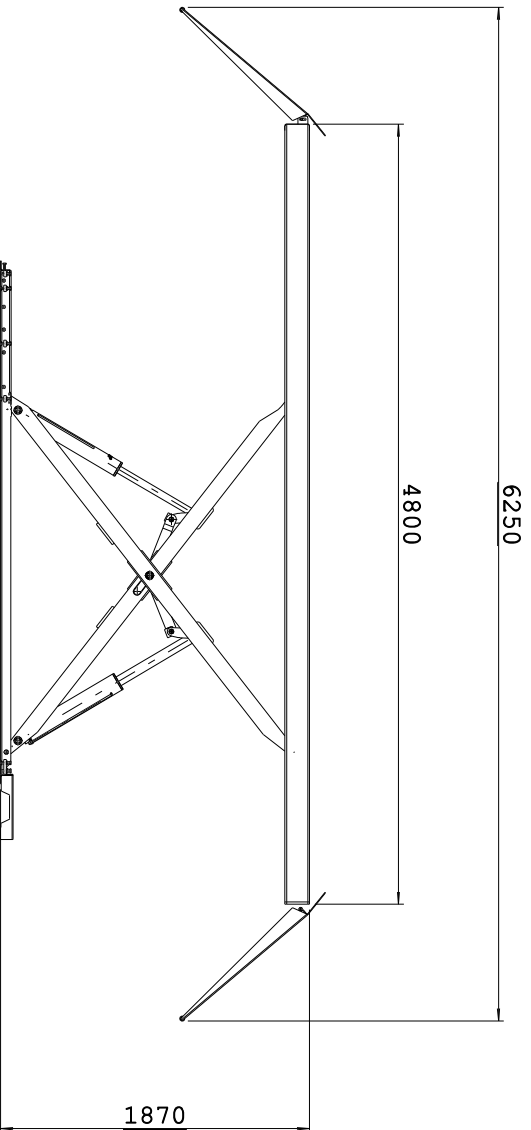

**HTC**  
Via degli Elettricisti - Zona Industriale  
64020 Sceme di Pineto (TE)  
Tel.: +390859463008 Fax: +390859462461  
www.htc-cnc.com e-mail: htc@htc-cnc.com

DISGNATO F.A.	DATA	REV.	SCALA: 1:1
CODICE COMPLESSIVO	2017	2	
QUANTITA' PER MACCHINA:		DESCRIZIONE	
POWER LP UP45-N 4800 SD			

IL PRESENTE DOCUMENTO E' PROPRIETA' DELLA HTC SRL E NON PUO' ESSERE RIPRODOTTO E PORTATO A CONOSCENZA DI TERZI SENZA L'AUTORIZZAZIONE SCRITTA  
This document is a property of HTC Srl and it cannot be reproduced or send to oth



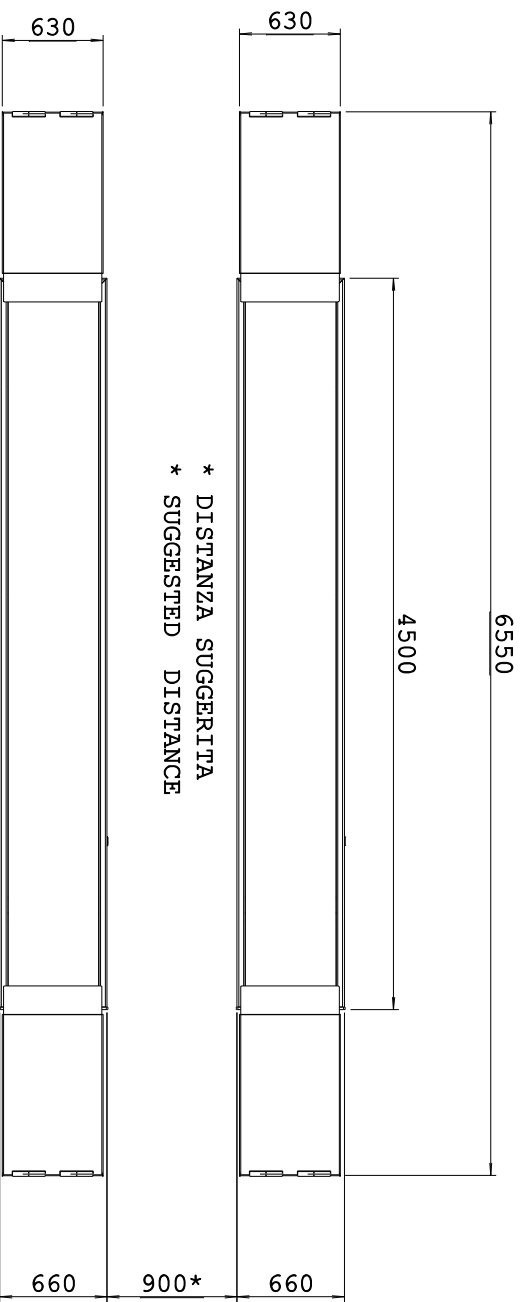
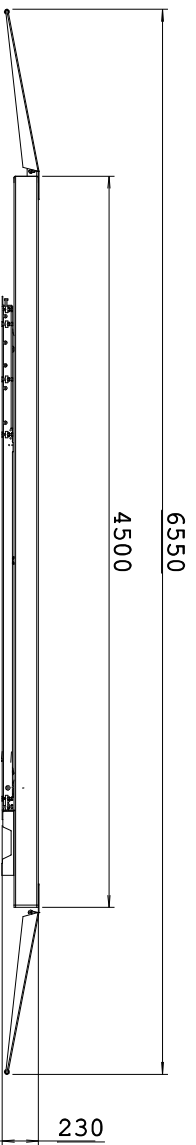
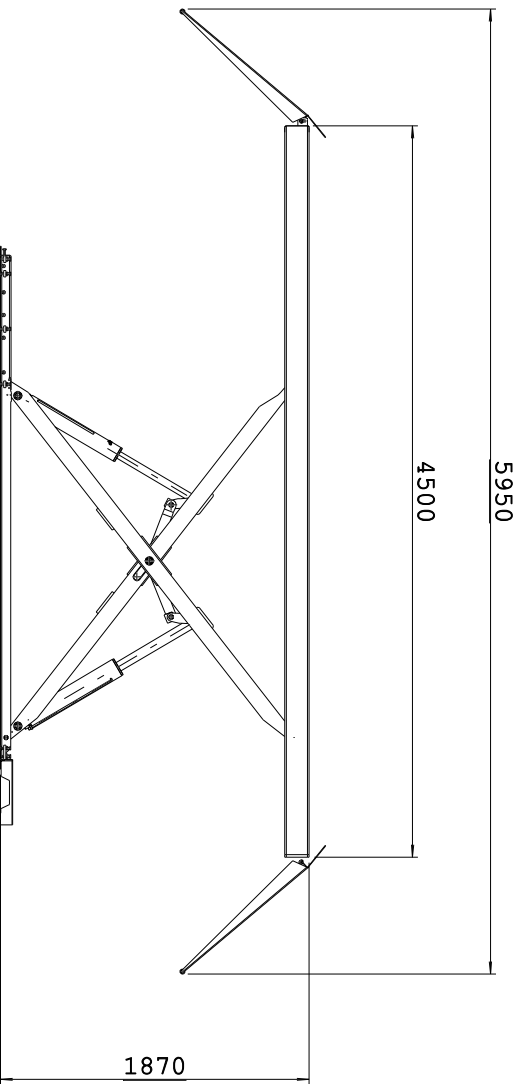

\* DISTANZA SUGGERITA  
 \* SUGGESTED DISTANCE

**HTC**  
 Via degli Elettricisti - Zona Industriale  
 64020 Sceme di Pineto (TE)  
 Tel.: +390859463008 Fax:+390859462461  
 www.htc-cnc.com e-mail: htc@htc-cnc.com

DISEGNATO F.A.	DATA 2017	REV. 2	DESCRIZIONE
CODICE COMPLESSIVO	QUANTITA' PER MACCHINA:	SCALA: 1:1	POWER LP UP45-N 4500 SD