

\* DISTANZA SUGGERITA  
\* SUGGESTED DISTANCE

**HTC**  
Via degli Elettricisti - Zona Industriale  
64020 Sceme di Pineto (TE)  
Tel.: +390859463008 Fax:+390859462461  
www.htc-cnc.com e-mail: htc@htc-cnc.com

DISGNATO F.A.	DATA 2017	REV. 2	SCALA: 1:1
CODICE COMPLESSIVO	QUANTITA' PER MACCHINA:	DESCRIZIONE	
	POWER LP UP45 LT	4500 SS	

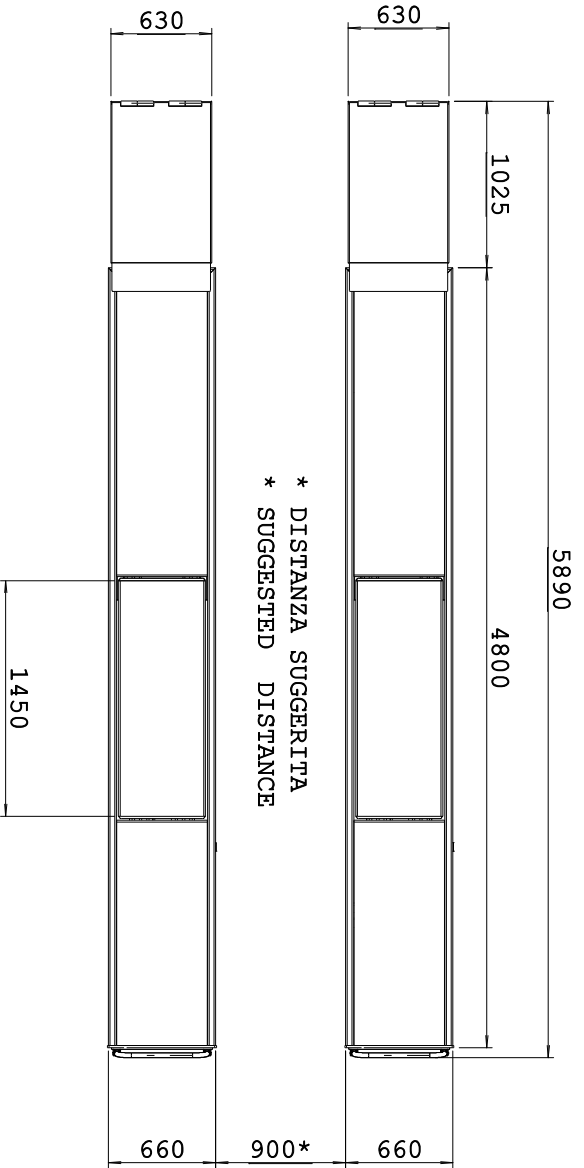
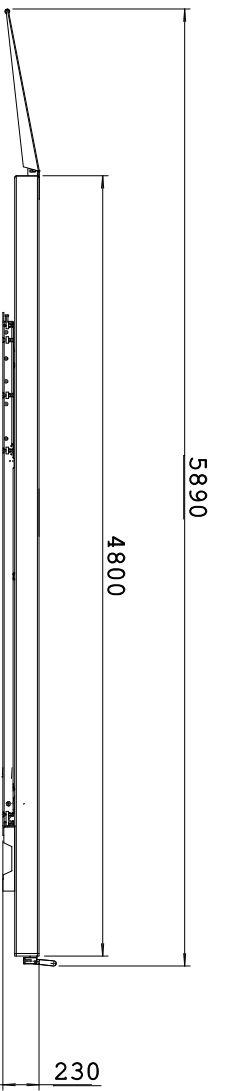
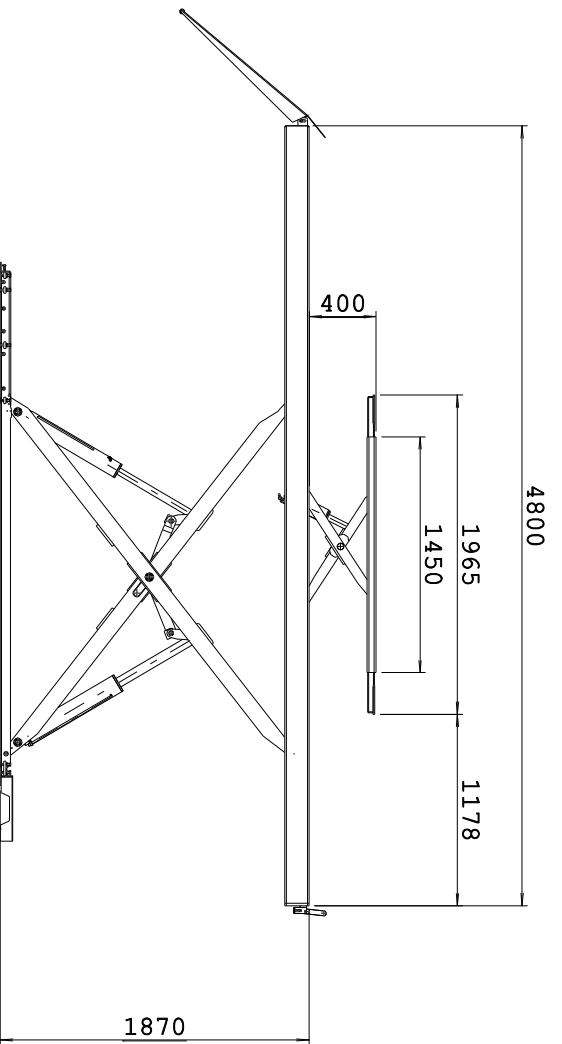

\* DISTANZA SUGGERITA  
 \* SUGGESTED DISTANCE

# HTC

Via degli Elettricisti - Zona Industriale  
 64020 Sceme di Pineto (TE)  
 Tel.: +390859463008 Fax:+390859462461  
 www.htc-cnc.com e-mail: htc@cnc.com

DISEGNATO F.A.	DATA 2017	REV. 2	SCALA: 1:1
CODICE COMPLESSIVO	QUANTITA' PER MACCHINA:	DESCRIZIONE	
	POWER LP UP45 LT	4800 SS	

IL PRESENTE DOCUMENTO E' PROPRIETA' DELLA HTC SRL E NON PUO' ESSERE RIPRODOTTO E PORTATO A CONOSCENZA DI TERZI SENZA L'AUTORIZZAZIONE SCRITTA  
 This document is a property of HTC Srl and it cannot be reproduced or send to oth

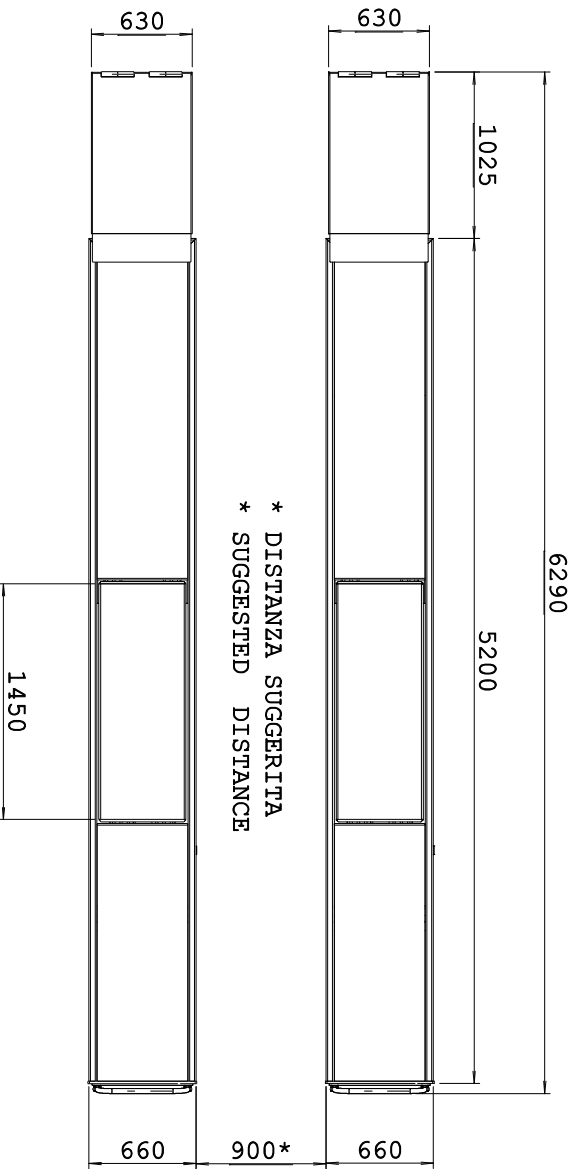
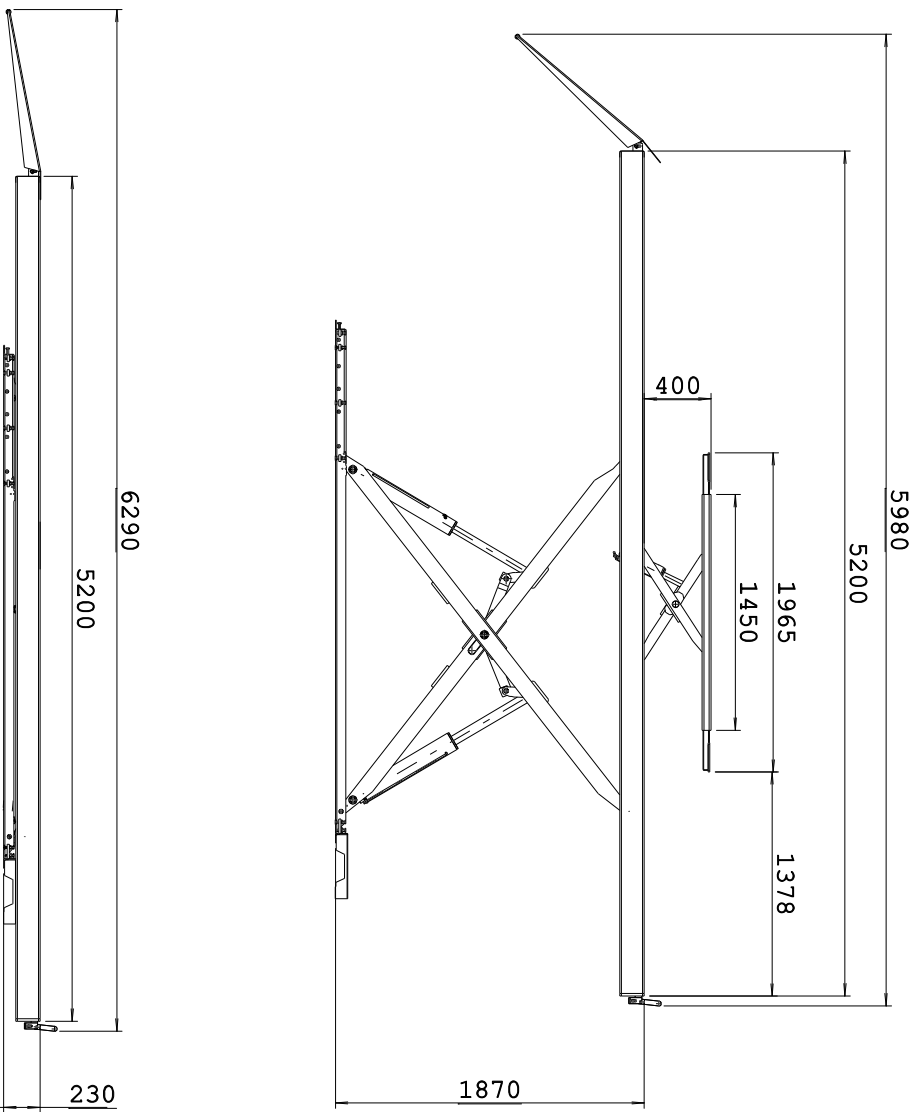

\* DISTANZA SUGGERITA  
\* SUGGESTED DISTANCE

**HTC**  
Via degli Elettricisti - Zona Industriale  
64020 Sceme di Pineto (TE)  
Tel.: +390859463008 Fax:+390859462461  
www.htc-cnc.com e-mail: htc@cnc.com

DISEGNATO F.A.	DATA 2017	REV. 2	SCALA: 1:1
CODICE COMPLESSIVO	QUANTITA' PER MACCHINA:	DESCRIZIONE	
	POWER IP UP45 IT 5200 SS		

IL PRESENTE DOCUMENTO E' PROPRIETA' DELLA HTC SRL E NON PUO' ESSERE RIPRODOTTO E PORTATO A CONOSCENZA DI TERZI SENZA L'AUTORIZZAZIONE SCRITTA  
This document is a property of HTC Srl and it cannot be reproduced or send to ot

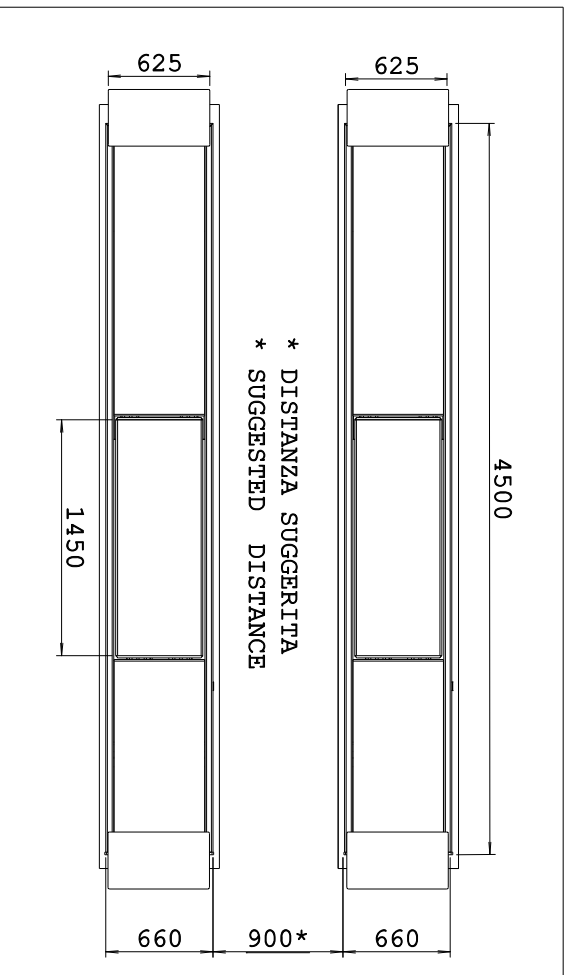
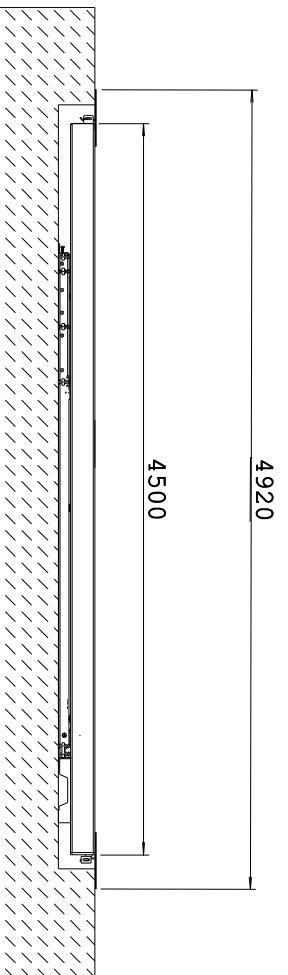
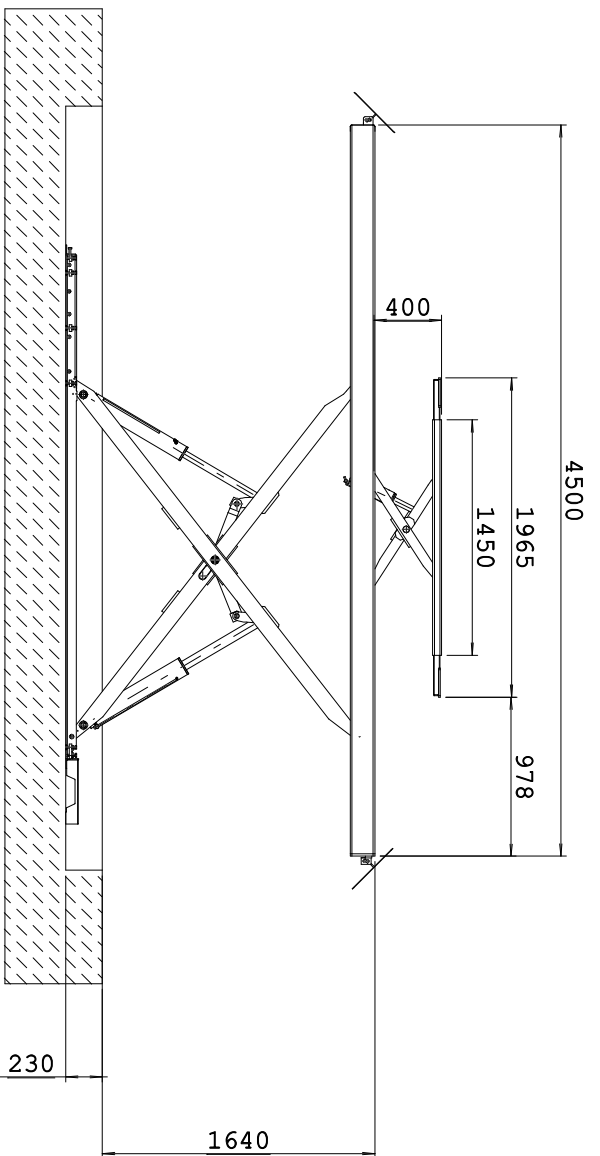

# HTC

Via degli Elettricisti - Zona Industriale  
64020 Sceme di Pinateo (TE)  
Tel.: +390859463008 Fax: +390859462461  
www.htc-cnc.com e-mail: htc@cnc.com

DISEGNATO F. A.	DATA 2017	REV. 2	SCALA: 1:1
CODICE COMPLESSIVO	QUANTITA' PER MACCHINA:	DESCRIZIONE	
	POWER LP UP45-LT	4500 I	

IL PRESENTE DOCUMENTO E' PROPRIETA' DELLA HTC SRL E NON PUO' ESSERE RIPRODOTTO E PORTATO A CONOSCENZA DI TERZI SENZA L'AUTORIZZAZIONE SCRITTA

This document is a property of HTC Srl and it cannot be reproduced or send to of

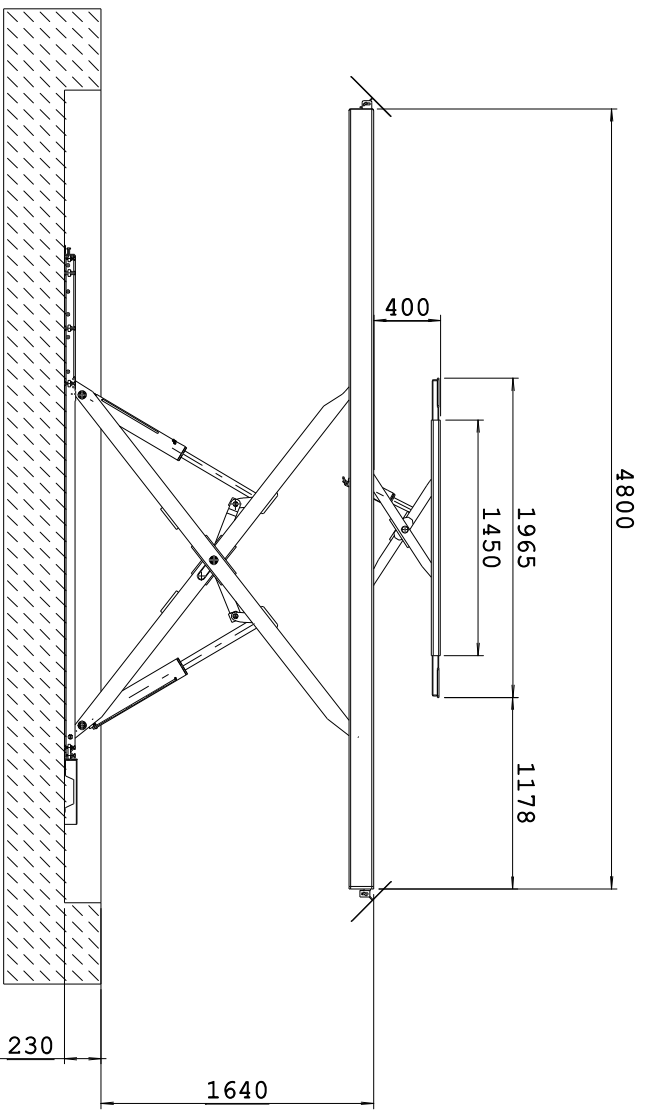

J - J

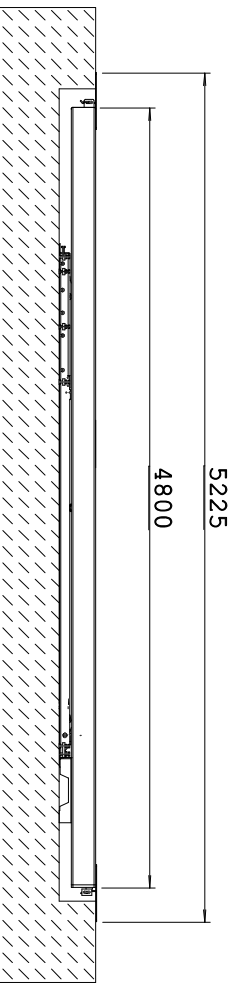

I - I

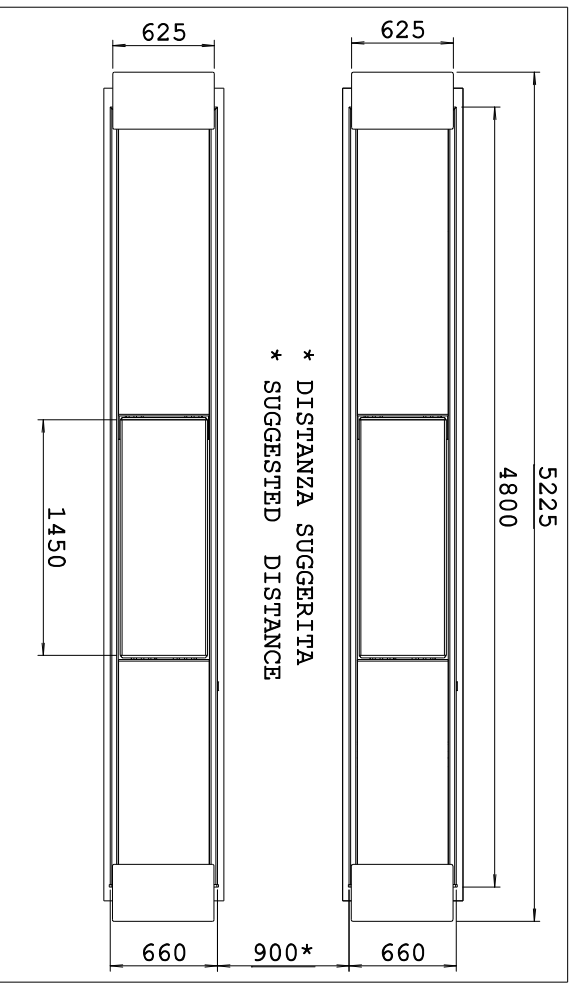

# HTC

Via degli Elettricisti - Zona Industriale  
 64020 Sceme di Pineto (TE)  
 Tel.: +390859463008 Fax:+390859462461  
 www.htc-cnc.com e-mail: htc@htc-cnc.com

DISEGNATO F.A.	DATA 2017	REV. 2	
CODICE COMPLESSIVO	QUANTITA' PER MACCHINA:	DESCRIZIONE	SCALA: 1:1
	POWER LP UP45-LT	4800 I	

IL PRESENTE DOCUMENTO E' PROPRIETA' DELLA HTC SRL E NON PUO' ESSERE RIPRODOTTO E PORTATO A CONOSCENZA DI TERZI SENZA L'AUTORIZZAZIONE SCRITTA  
 This document is a property of HTC Srl and it cannot be reproduced or send to ot

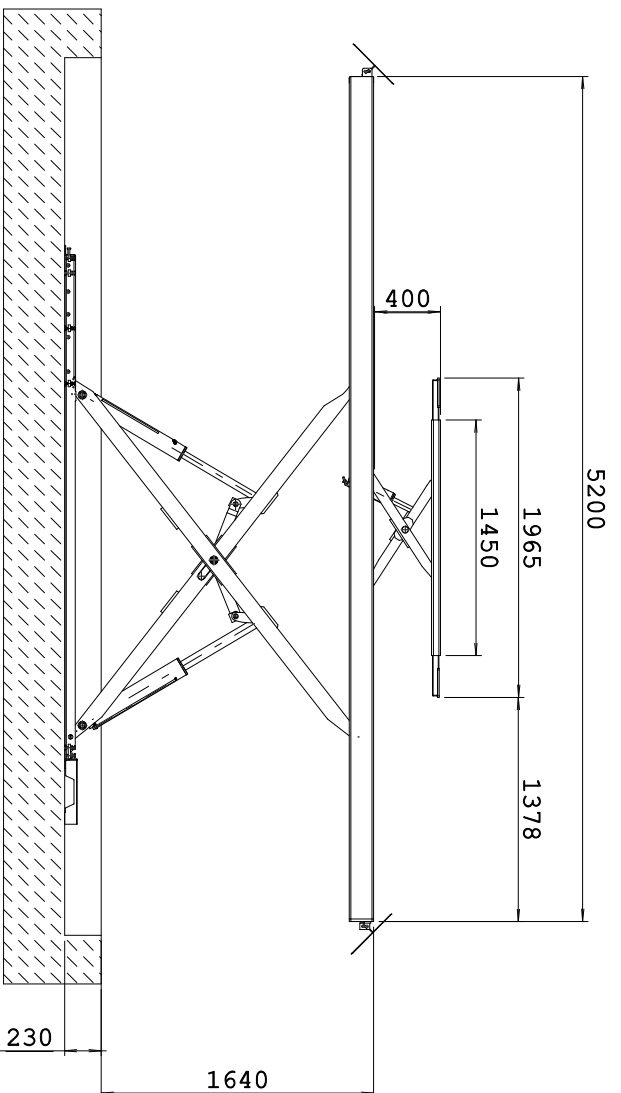

K - K

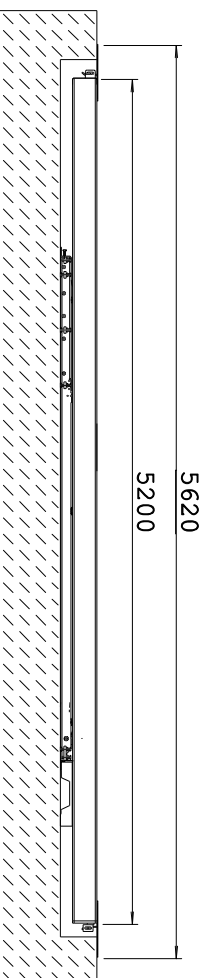

L - L

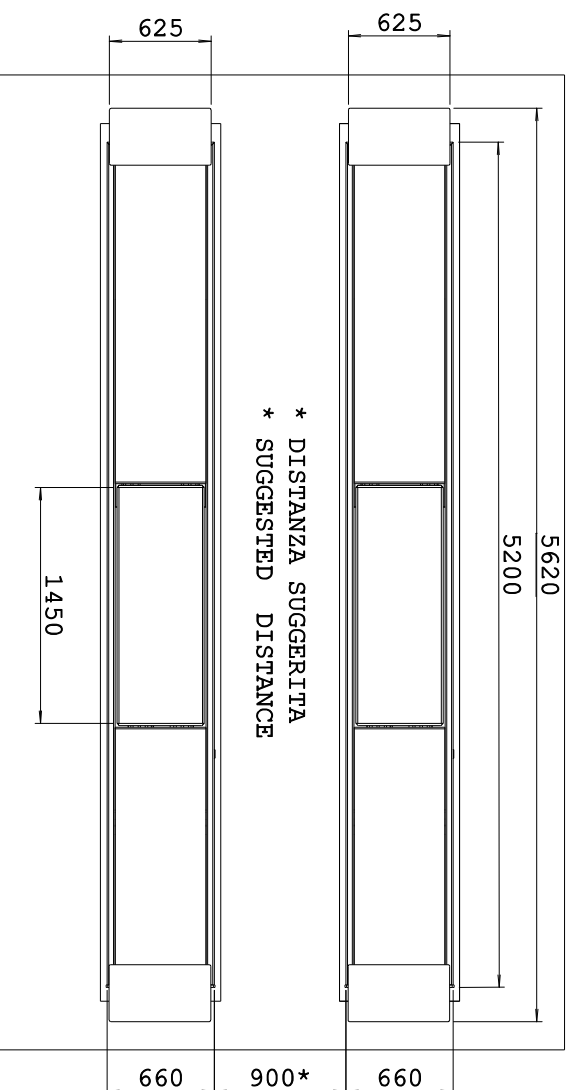

\* DISTANZA SUGGERITA  
\* SUGGESTED DISTANCE

# HTC

Via degli Elettricisti - Zona Industriale  
64020 Scame di Pineto (TE)  
Tel.: +39089463008 Fax:+39089462461  
www.htc-cnc.com e-mail: htc@htc-cnc.com

DISEGNATO F.A.	DATA 2017	REV. 2	SCALA: 1:1
CODICE COMPLESSIVO	QUANTITA' PER MACCHINA:	DESCRIZIONE	
	POWER LP UP45-LP 5200 I		

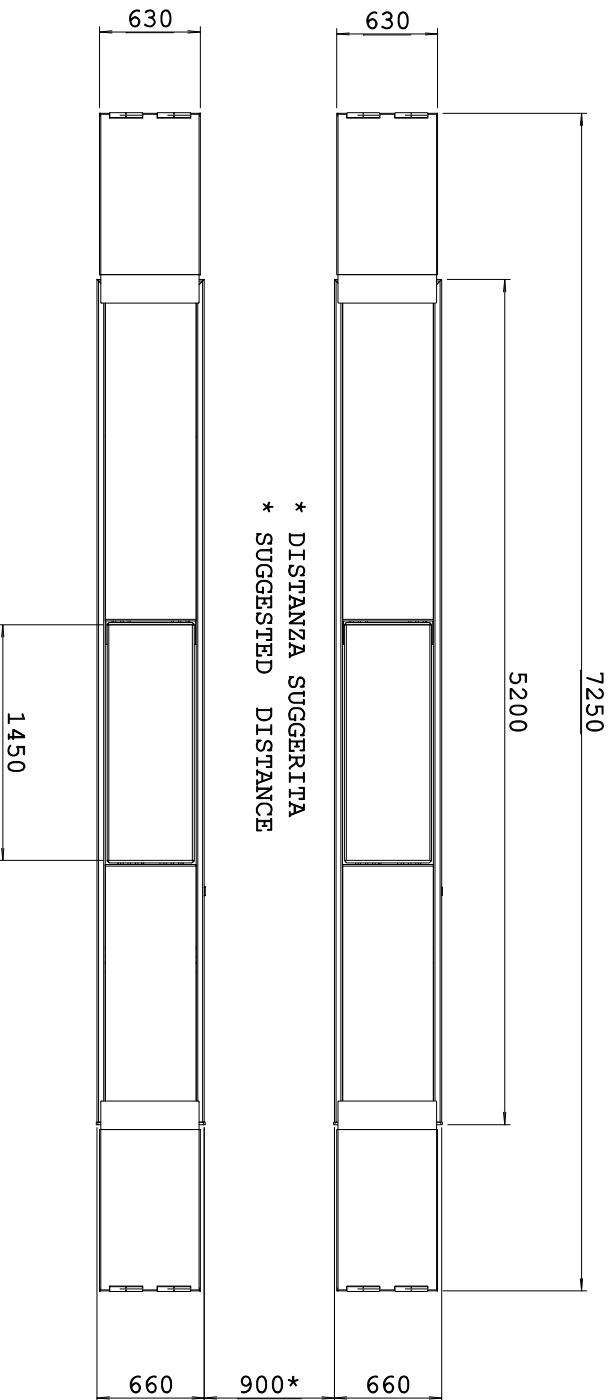
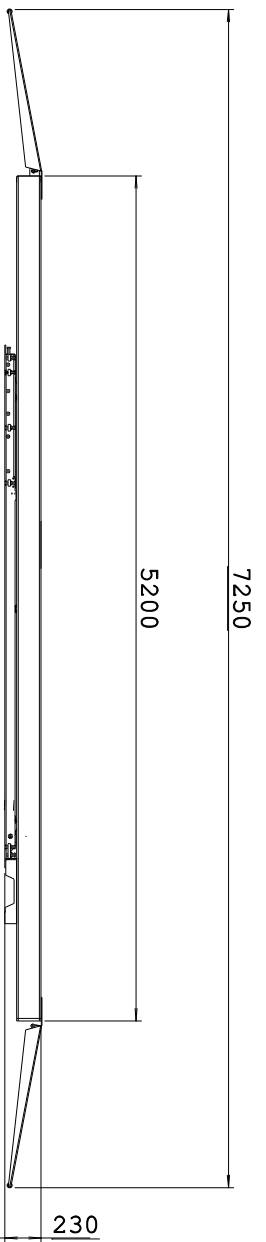
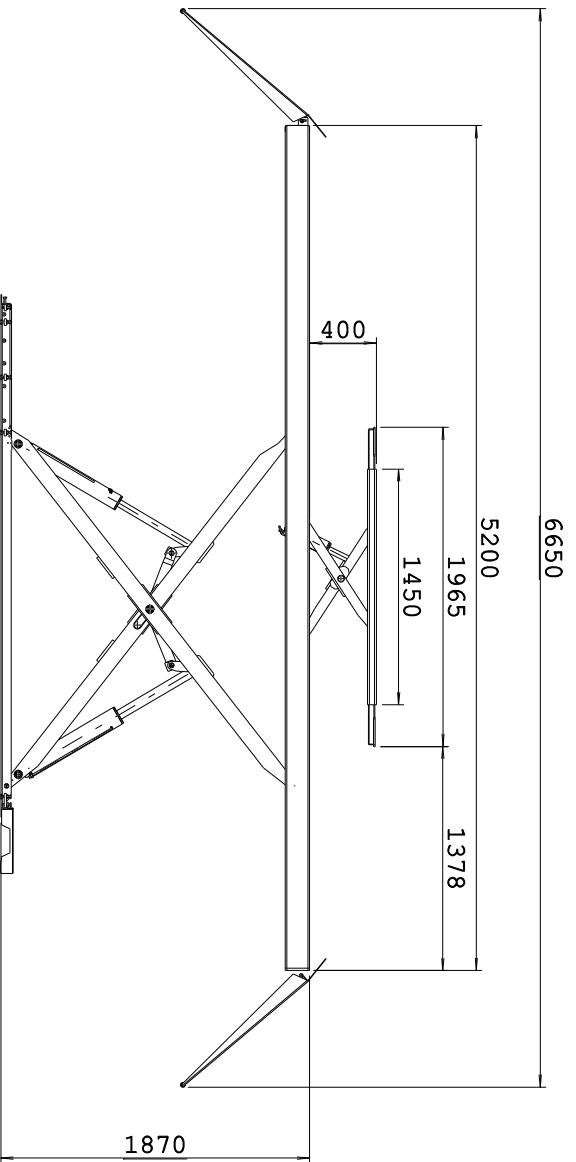

\* DISTANZA SUGGERITA  
\* SUGGESTED DISTANCE

**HTC**  
Via degli Elettricisti - Zona Industriale  
64020 Sceme di Pinateo (TE)  
Tel.: +390859463008 Fax:+390859462461  
www.htc-cnc.com e-mail: htc@htc-cnc.com

DISEGNATO F.A.	DATA 2017	REV. 2	SCALA: 1:1
CODICE COMPLESSIVO	QUANTITA' PER MACCHINA:	DESCRIZIONE	
	POWER LP UP45-1T	5200 SD	

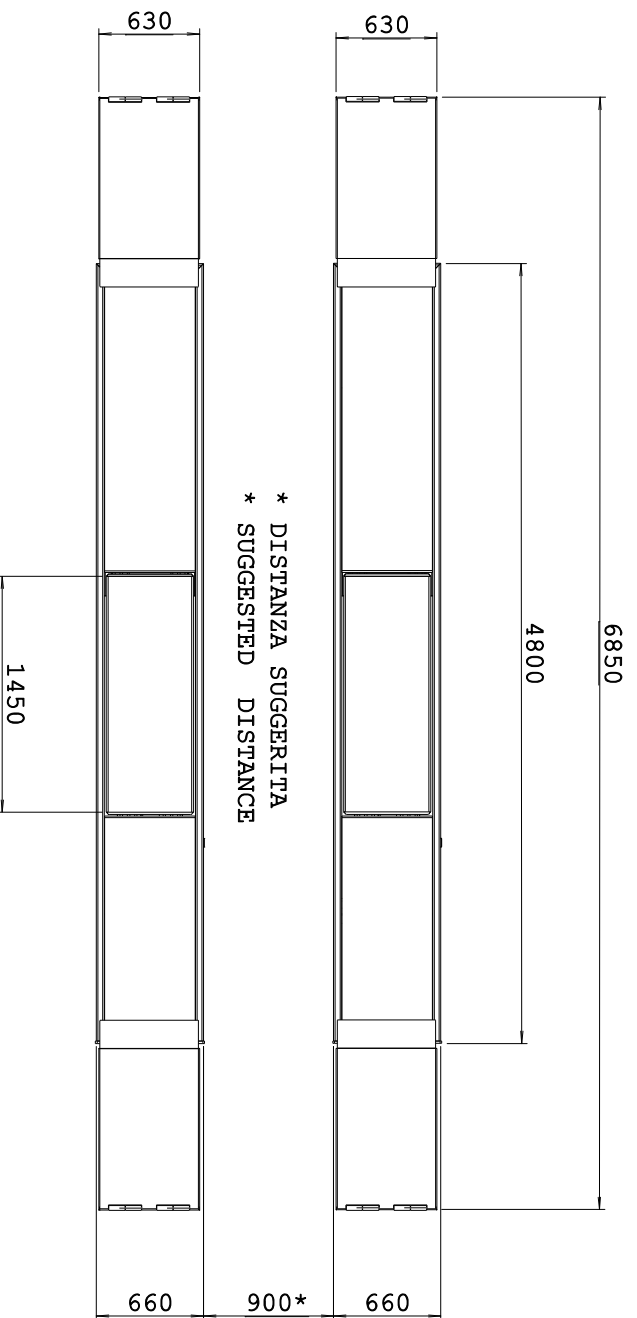
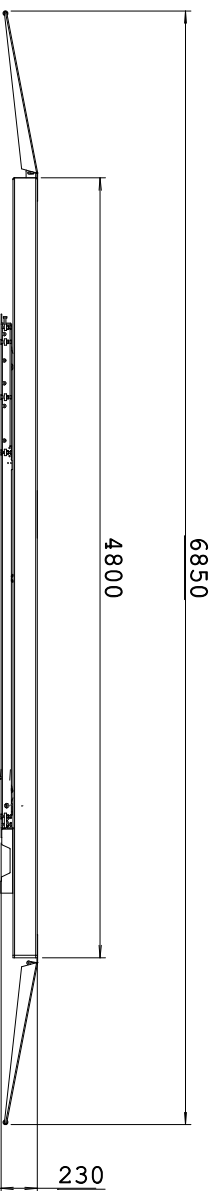
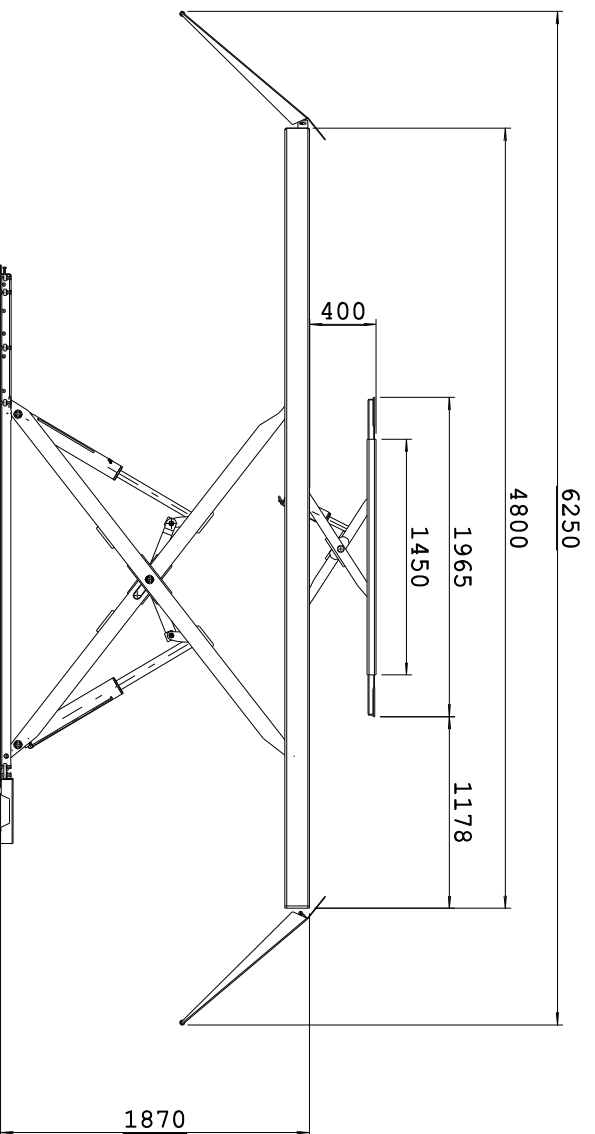

**HTC**  
Via degli Elettricisti - Zona Industriale  
64020 Sceme di Pineto (TE)  
Tel.: +390859463008 Fax:+390859462461  
www.htc-cnc.com e-mail: htc@htc-cnc.com

DISEGNATO F.A.	DATA 2017	REV. 2	SCALA: 1:1
CODICE COMPLESSIVO	QUANTITA' PER MACCHINA:	DESCRIZIONE	POWER LP UP45-LT 4800 SD



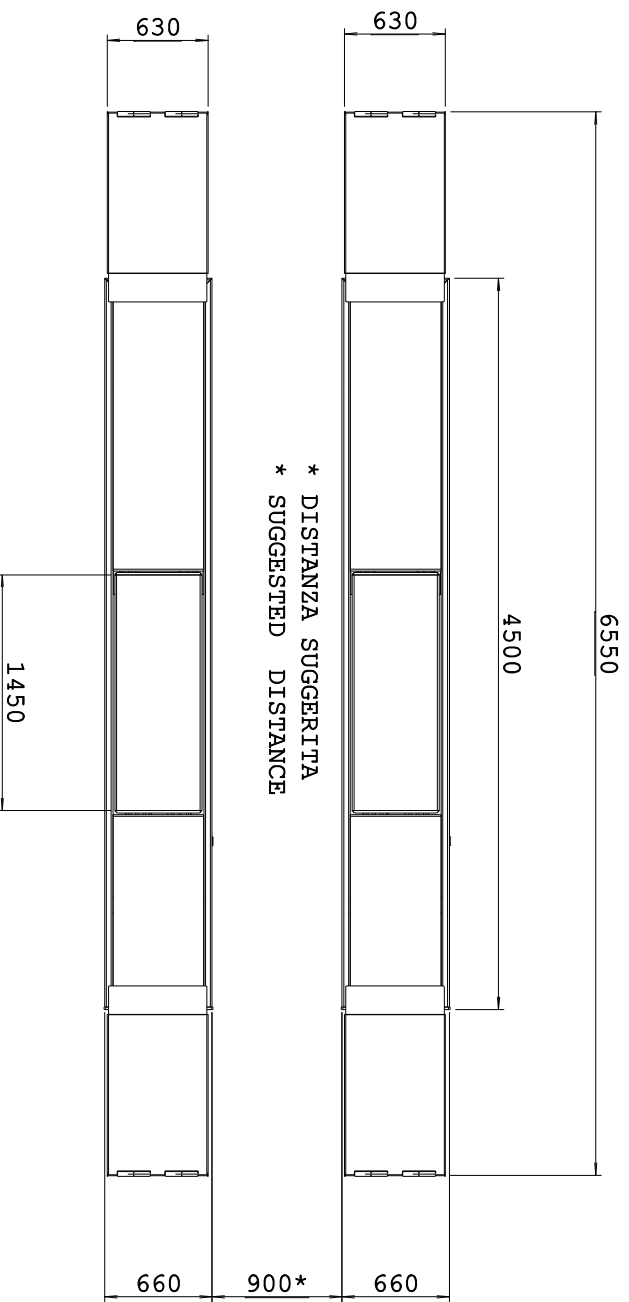
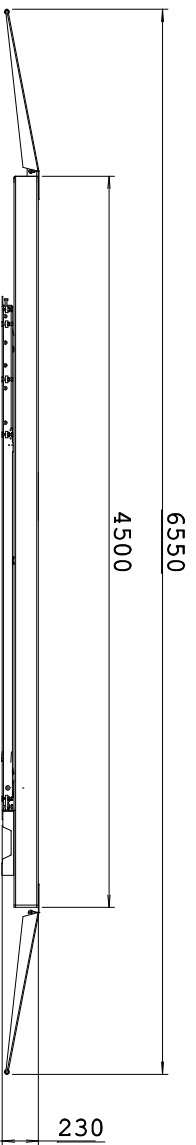
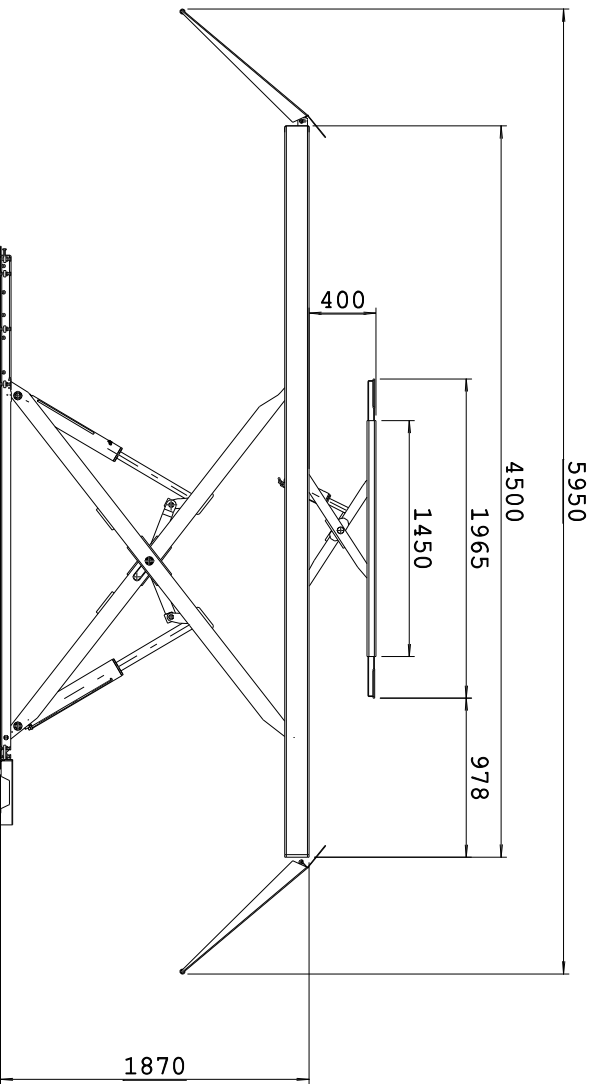

\* DISTANZA SUGGERITA  
 \* SUGGESTED DISTANCE

**HTC**  
 Via degli Elettricisti - Zona Industriale  
 64020 Scame di Pineto (TE)  
 Tel.: +390859463008 Fax: +390859462461  
 www.htc-cnc.com e-mail: htc@htc-cnc.com

DISEGNATO F.A.	DATA 2017	REV. 2	SCALA: 1:1
CODICE COMPLESSIVO	QUANTITA' PER MACCHINA:	DESCRIZIONE	
	POWER LP UP45-1T	4500 SD	

IL PRESENTE DOCUMENTO E' PROPRIETA' DELLA HTC SRL E NON PUO' ESSERE RIPRODOTTO E PORTATO A CONOSCENZA DI TERZI SENZA L'AUTORIZZAZIONE SCRITTA  
 This document is a property of HTC Srl and it cannot be reproduced or send to of