

\* DISTANZA SUGGERITA  
\* SUGGESTED DISTANCE

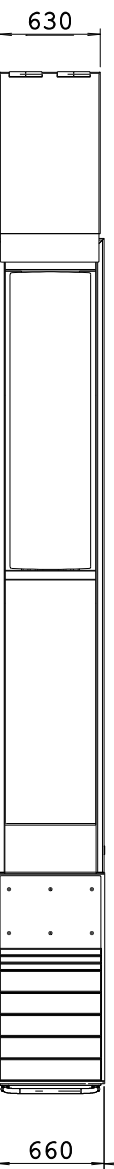

# HTC

Via degli Elettricisti - Zona Industriale  
64020 Sceme di Pineto (TE)  
Tel.: +390859463008 Fax:+390859462461  
www.htc-cnc.com e-mail: htc@htc-cnc.com

DISEGNATO F.A.	DATA 2017	REV. 2	
CODICE COMPLESSIVO	QUANTITA' PER MACCHINA:	DESCRIZIONE	SCALA: 1:1
	POWER IP UP45 AS	5200 SS	

IL PRESENTE DOCUMENTO E' PROPRIETA' DELLA HTC SRL E NON PUO' ESSERE RIPRODOTTO E PORTATO A CONOSCENZA DI TERZI SENZA L'AUTORIZZAZIONE SCRITTA  
This document is a property of HTC Srl and it cannot be reproduced or send to ot

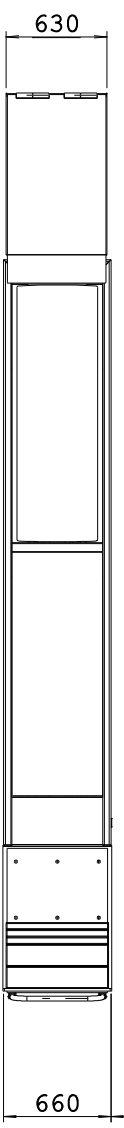
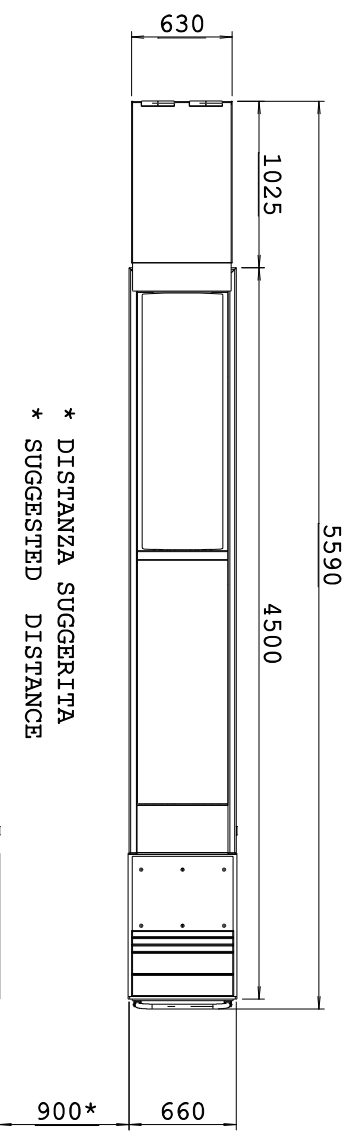
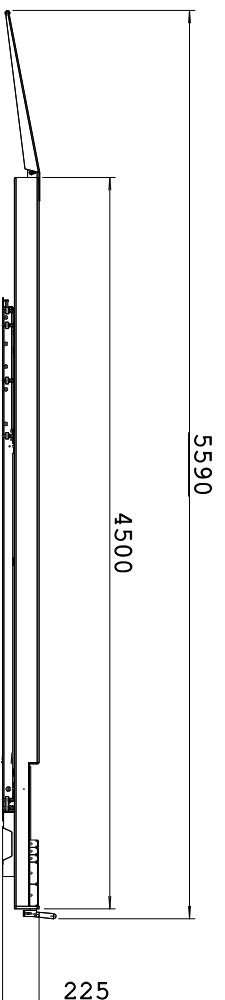
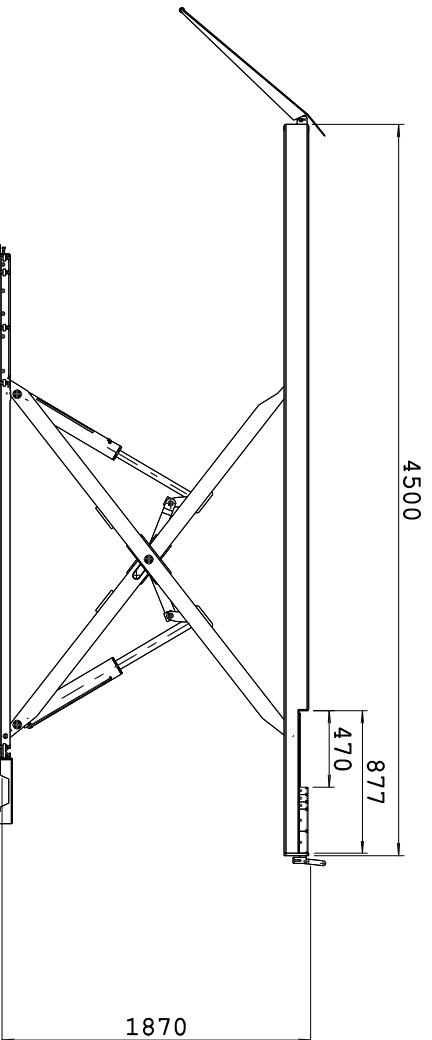

**HTC**  
Via degli Elettricisti - Zona Industriale  
64020 Sceme di Pineto (TE)  
Tel.: +390859463008 Fax: +390859462461  
www.htc-cnc.com e-mail: htc@htc-cnc.com

DISGNATO F.A.	DATA 2017	REV. 2	
CODICE COMPLESSIVO	QUANTITA' PER MACCHINA:	DESCRIZIONE	SCALA: 1:1
	POWER LP UP45 AS	4500 SS	

IL PRESENTE DOCUMENTO E' PROPRIETA' DELLA HTC SRL E NON PUO' ESSERE RIPRODOTTO E PORTATO A CONOSCENZA DI TERZI SENZA L'AUTORIZZAZIONE SCRITTA  
This document is a property of HTC Srl and it cannot be reproduced or send to oth

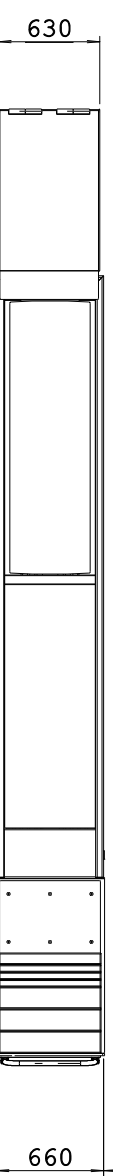
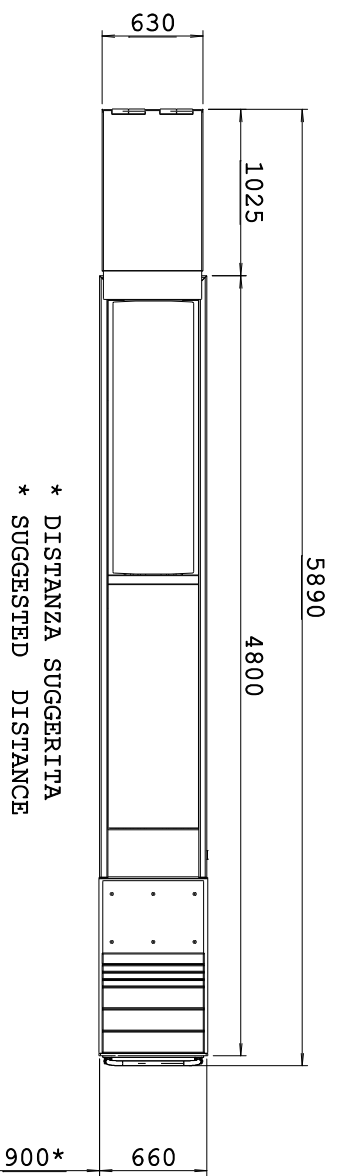
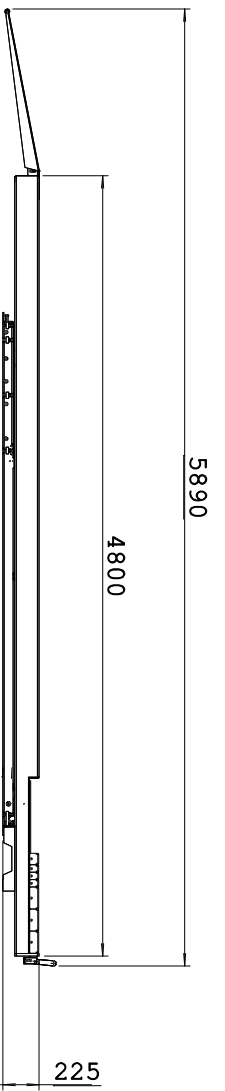
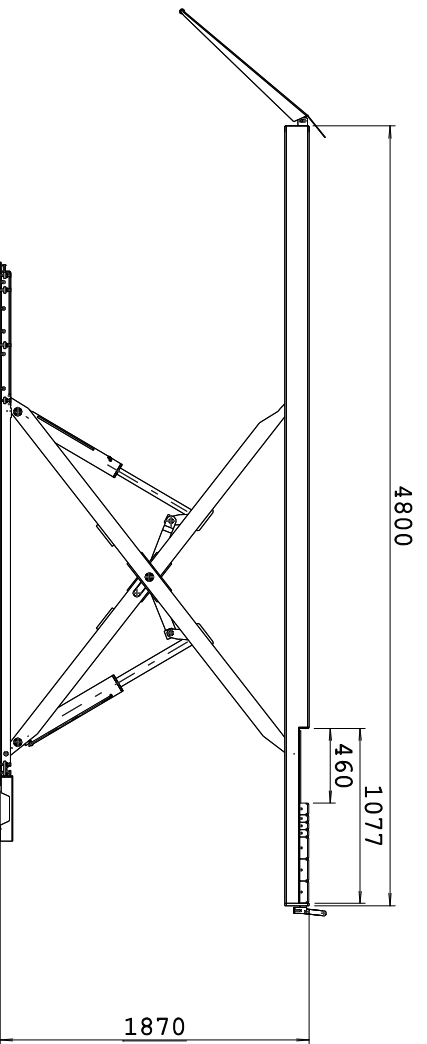

**HTC**  
Via degli Elettricisti - Zona Industriale  
64020 Scame di Pineto (TE)  
Tel.: +390859463008 Fax:+390859462461  
www.htc-cnc.com e-mail: htc@htc-cnc.com

DISEGNATO F.A.	DATA 2017	REV. 2	SCALA: 1:1
CODICE COMPLESSIVO	QUANTITA' PER MACCHINA:	DESCRIZIONE	
	POWER LP UP45 AS 4800 SS		

IL PRESENTE DOCUMENTO E' PROPRIETA' DELLA HTC SRL E NON PUO' ESSERE RIPRODOTTO E PORTATO A CONOSCENZA DI TERZI SENZA L'AUTORIZZAZIONE SCRITTA  
This document is a property of HTC Srl and it cannot be reproduced or send to oth

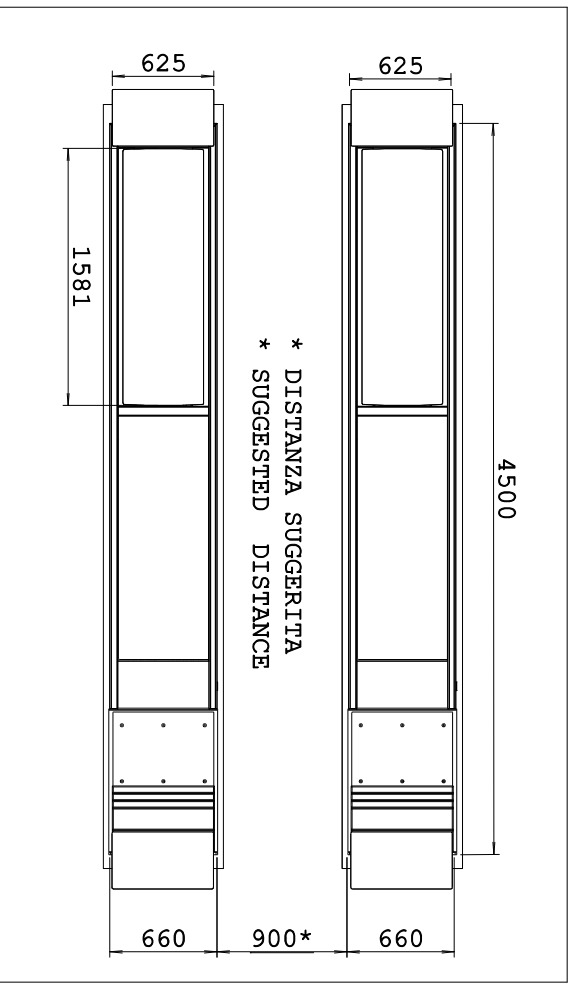
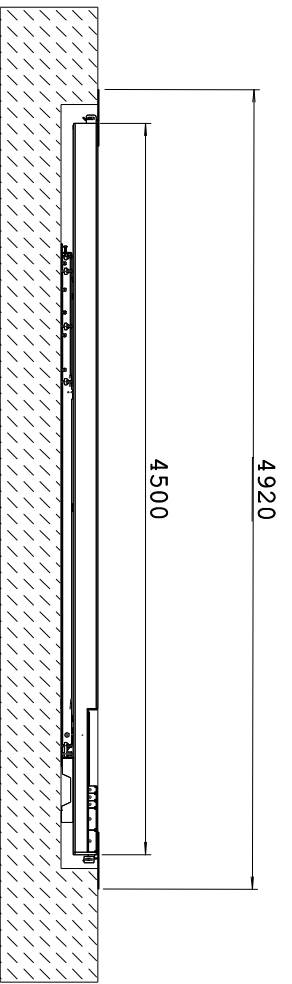
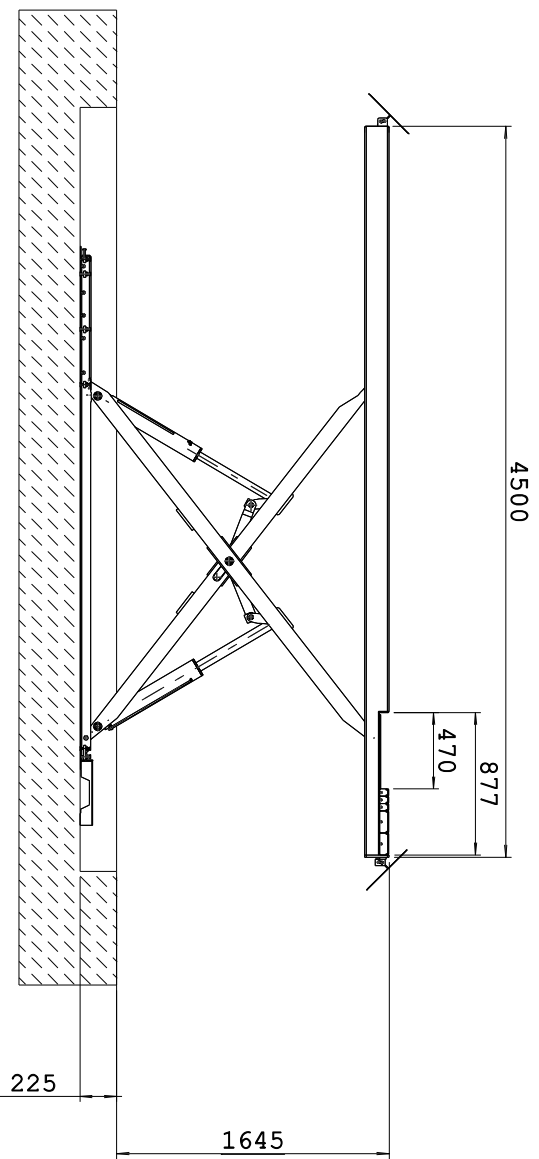

# HTC

Via degli Elettricisti - Zona Industriale  
64020 Sceme di Pineto (TE)  
Tel.: +390859463008 Fax: +390859462461  
www.htc-cnc.com e-mail: htc@cnc.com

DISEGNATO F. A.	DATA 2017	REV. 2	SCALA: 1:1
CODICE COMPLESSIVO	QUANTITA' PER MACCHINA:	DESCRIZIONE	
	POWER IP UP45-AS	4500 I	

IL PRESENTE DOCUMENTO E' PROPRIETA' DELLA HTC SRL E NON PUO' ESSERE RIPRODOTTO E PORTATO A CONOSCENZA DI TERZI SENZA L'AUTORIZZAZIONE SCRITTA  
This document is a property of HTC Srl and it cannot be reproduced or send to of

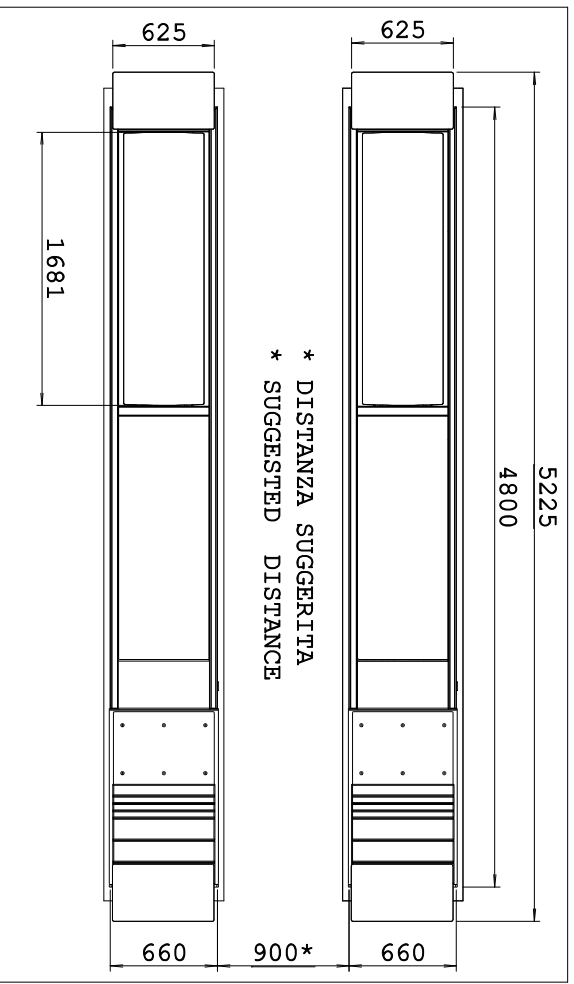
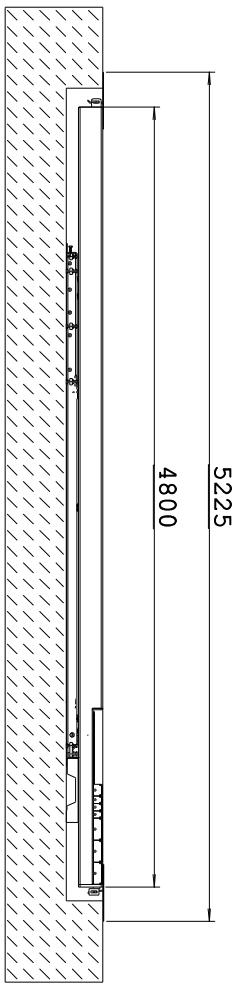
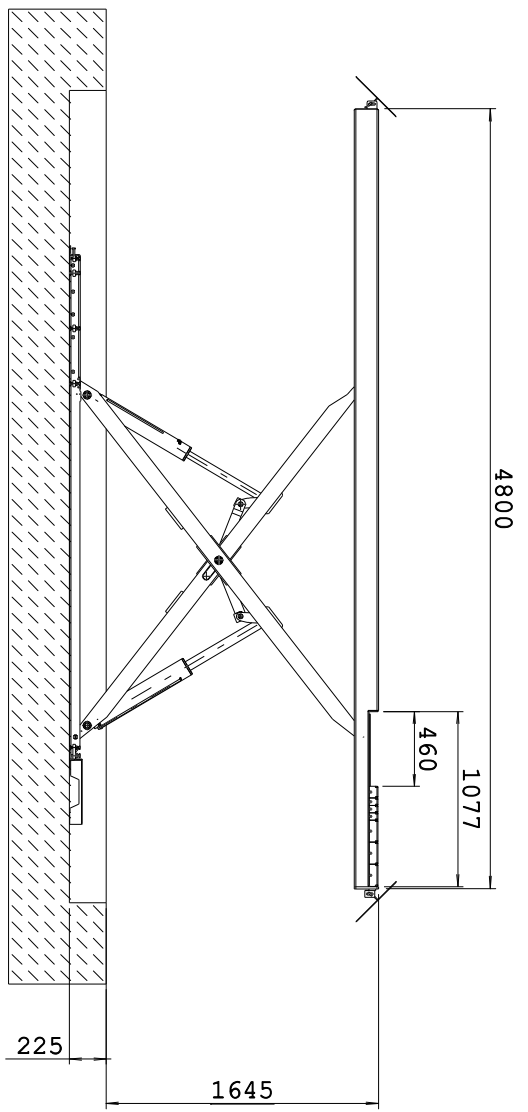

# HTC

Via degli Elettricisti - Zona Industriale  
 64020 Sceme di Pineto (TE)  
 Tel.: +390859463008 Fax: +390859462461  
 www.htc-cnc.com e-mail: htc@htc-cnc.com

DISEGNATO F.A.	DATA 2017	REV. 2	
CODICE COMPLESSIVO	QUANTITA' PER MACCHINA:	DESCRIZIONE	SCALA: 1:1
	POWER LP UP45-AS	4800 I	

IL PRESENTE DOCUMENTO E' PROPRIETA' DELLA HTC SRL E NON PUO' ESSERE RIPRODOTTO E PORTATO A CONOSCENZA DI TERZI SENZA L'AUTORIZZAZIONE SCRITTA  
 This document is a property of HTC Srl and it cannot be reproduced or send to ot

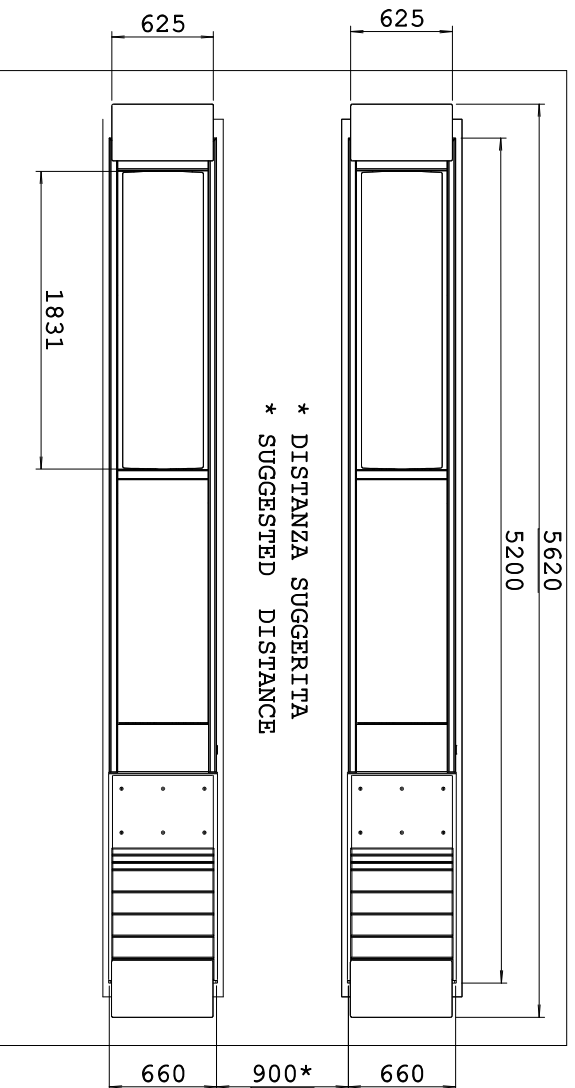
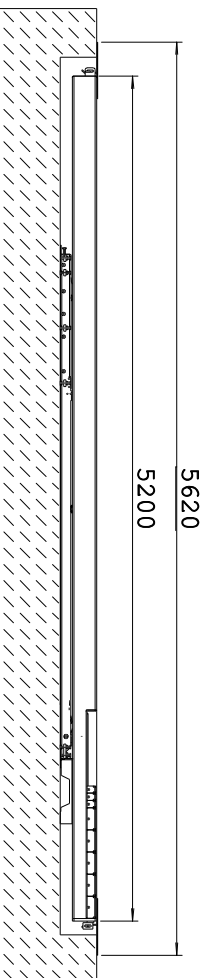
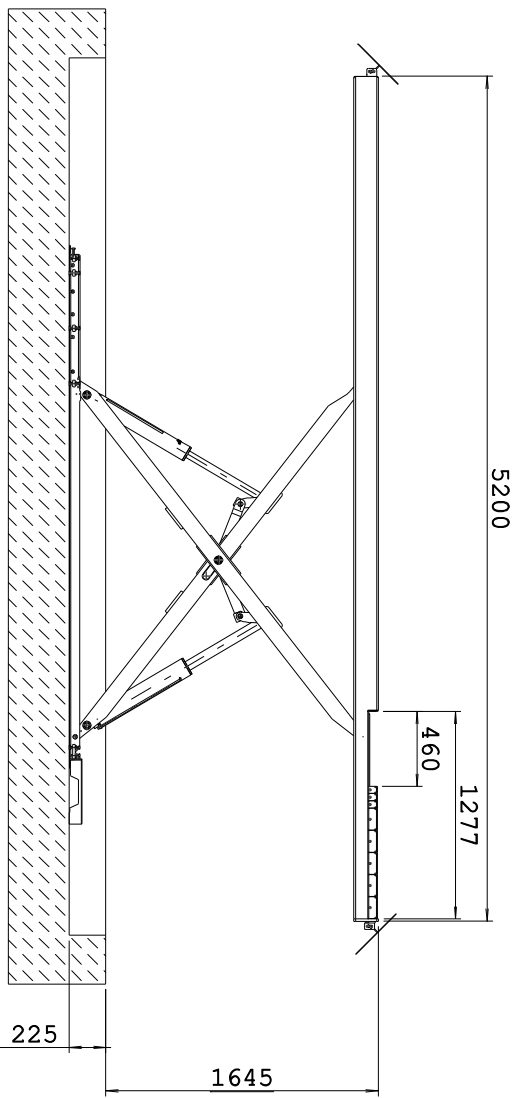

# HTC

Via degli Elettricisti - Zona Industriale  
64020 Sceme di Pineto (TE)  
Tel.: +390859463008 Fax:+390859462461  
www.htc-cnc.com e-mail: htc@htc-cnc.com

DISGNATO F.A.	DATA 2017	REV. 2	SCALA: 1:1
CODICE COMPLESSIVO	QUANTITA' PER MACCHINA:	DESCRIZIONE	
	POWER LP UP45-AS	5200 I	

IL PRESENTE DOCUMENTO E' PROPRIETA' DELLA HTC SRL E NON PUO' ESSERE RIPRODOTTO E PORTATO A CONOSCENZA DI TERZI SENZA L'AUTORIZZAZIONE SCRITTA  
This document is a property of HTC Srl and it cannot be reproduced or send to of

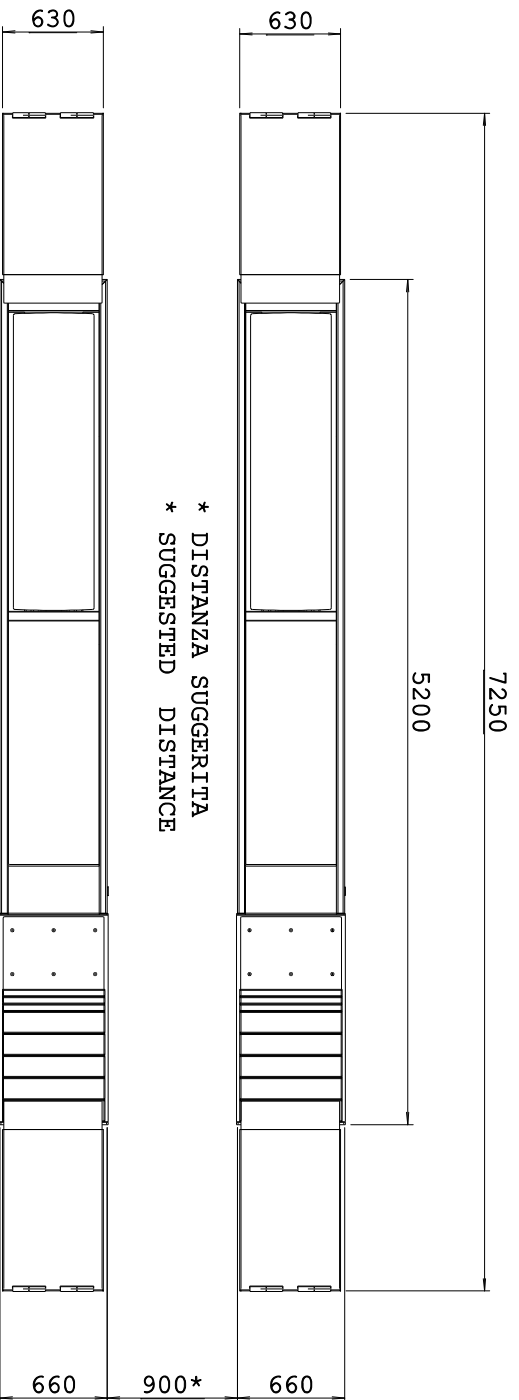
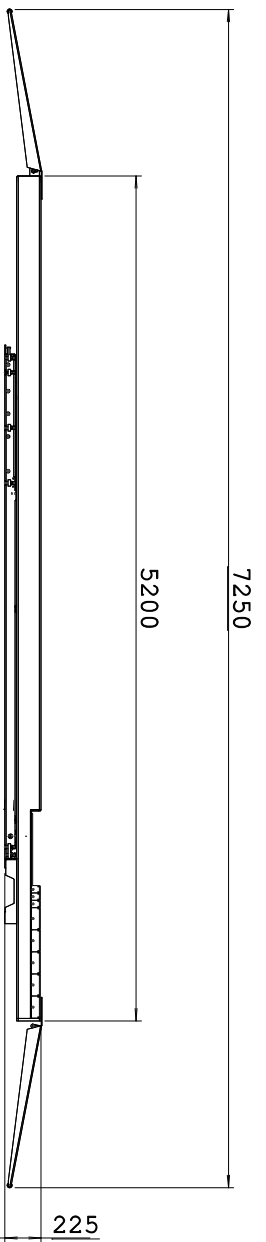
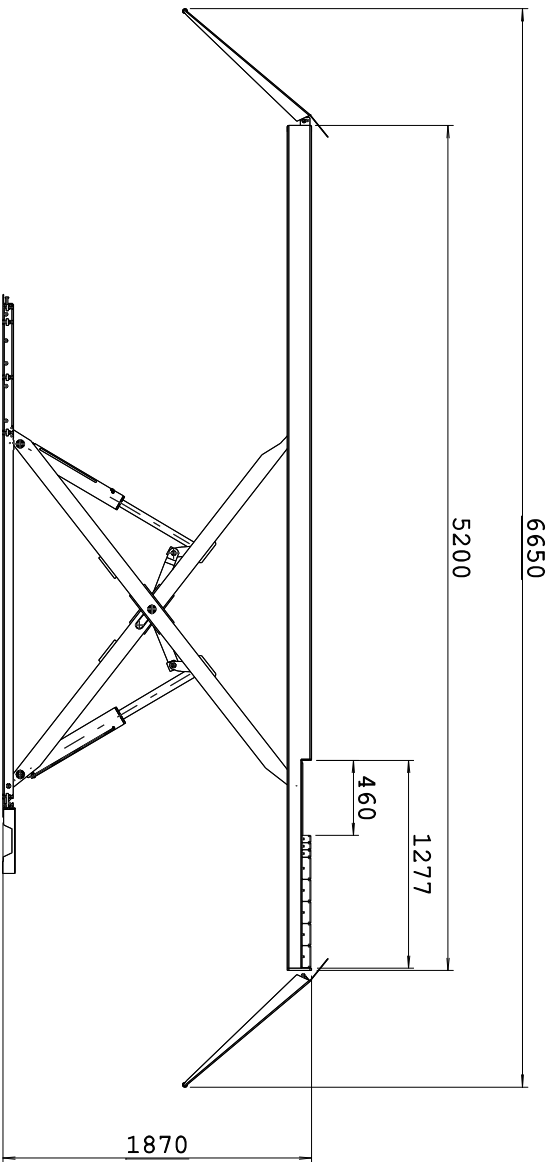

**HTC**  
Via degli Elettricisti - Zona Industriale  
64020 Scame di Pineto (TE)  
Tel.: +390859463008 Fax: +390859462461  
www.htc-cnc.com e-mail: htc@htc-cnc.com

DISEGNATO F.A.	DATA 2017	REV. 2
CODICE COMPLESSIVO	QUANTITA' PER MACCHINA:	DESCRIZIONE
	POWER LP UP45-AS	5200 SD
		SCALA: 1:1

IL PRESENTE DOCUMENTO E' PROPRIETA' DELLA HTC SRL E NON PUO' ESSERE RIPRODOTTO E PORTATO A CONOSCENZA DI TERZI SENZA L'AUTORIZZAZIONE SCRITTA  
This document is a property of HTC Srl and it cannot be reproduced or send to ot

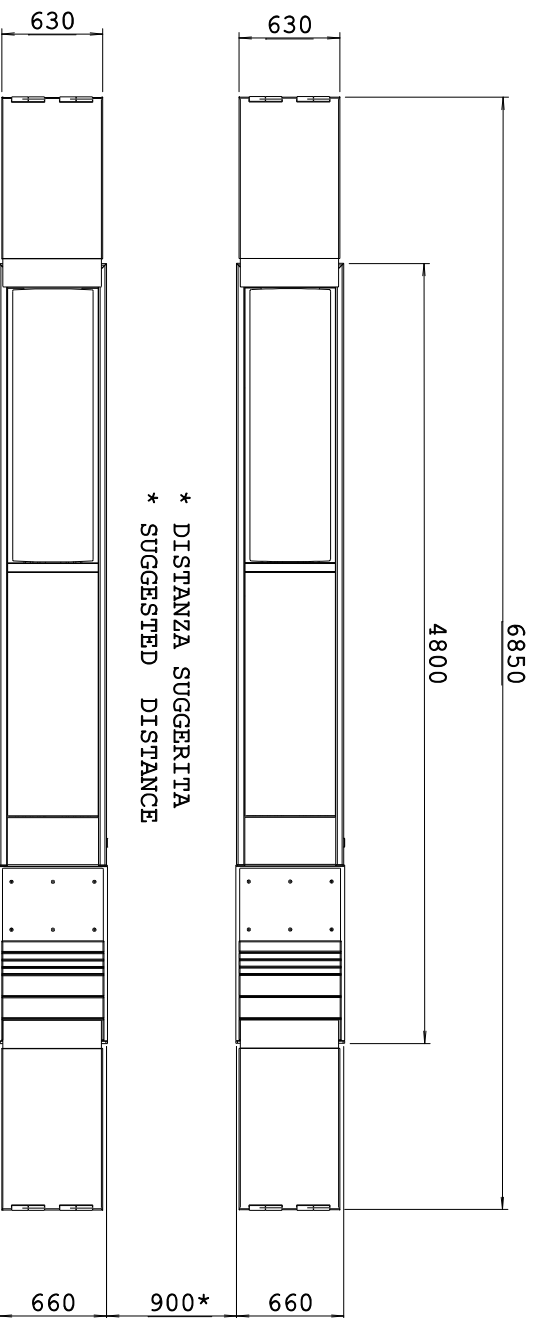
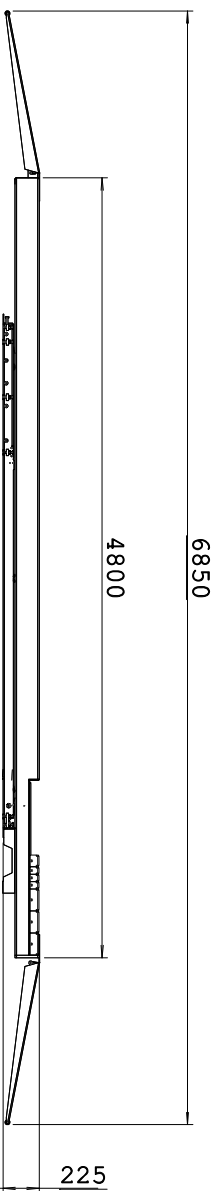
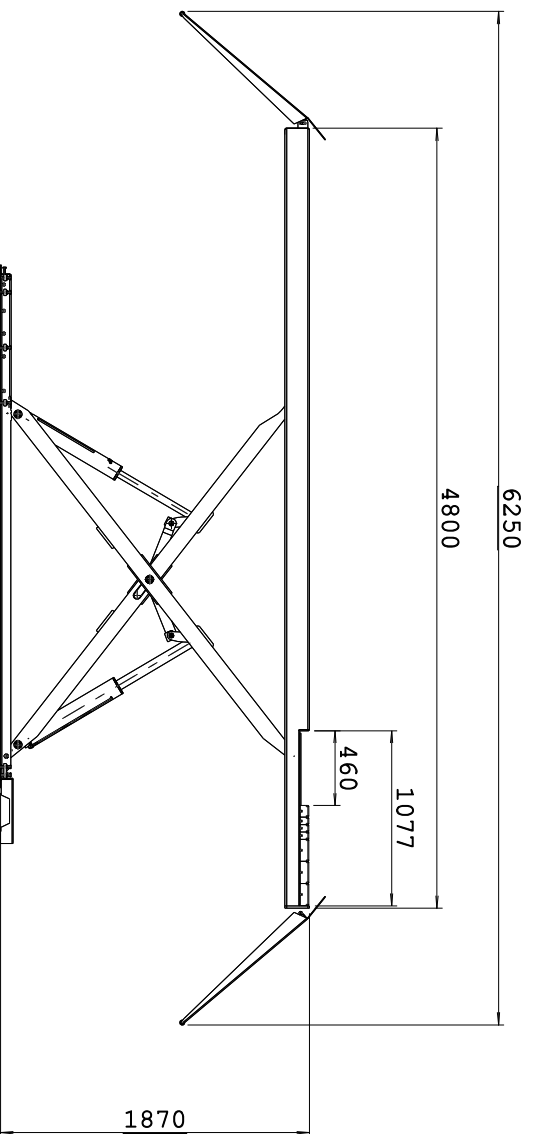

**HTC**  
Via degli Elettricisti - Zona Industriale  
64020 Sceme di Pineto (TE)  
Tel.: +390859463008 Fax: +390859462461  
www.htc-cnc.com e-mail: htc@htc-cnc.com

DISGNATO F.A.	DATA	REV.	SCALA: 1:1
CODICE COMPLESSIVO	2017	2	
QUANTITA' PER MACCHINA: DESCRIZIONE		POWER LP UP45-AS 4800 SD	



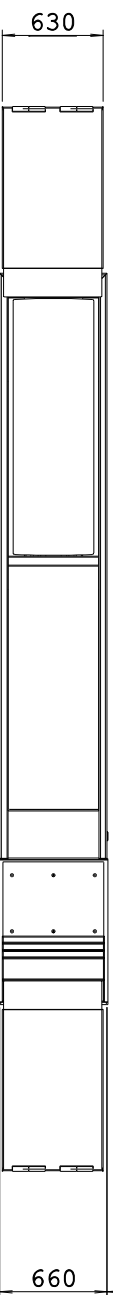
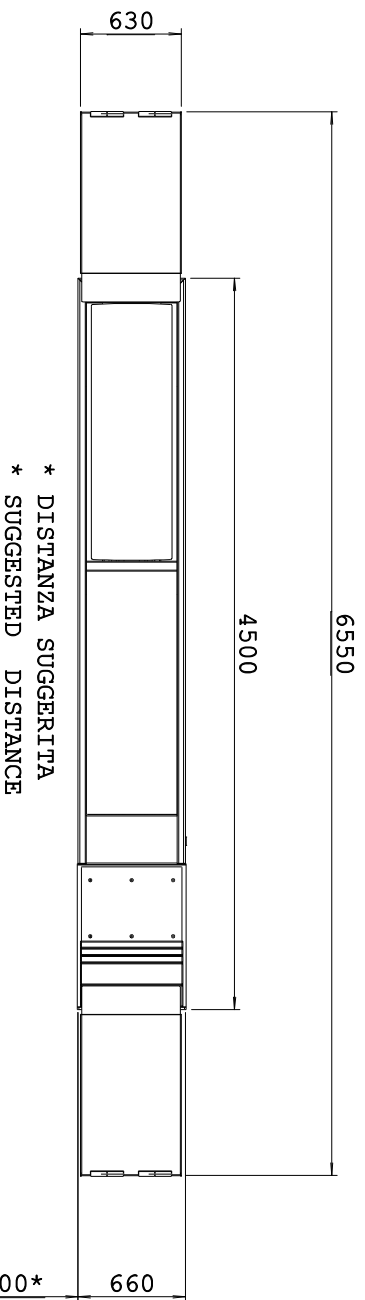
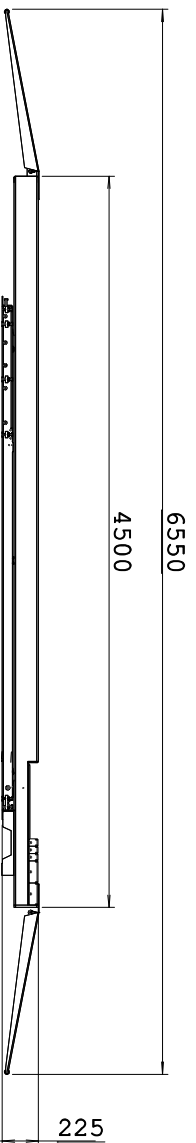
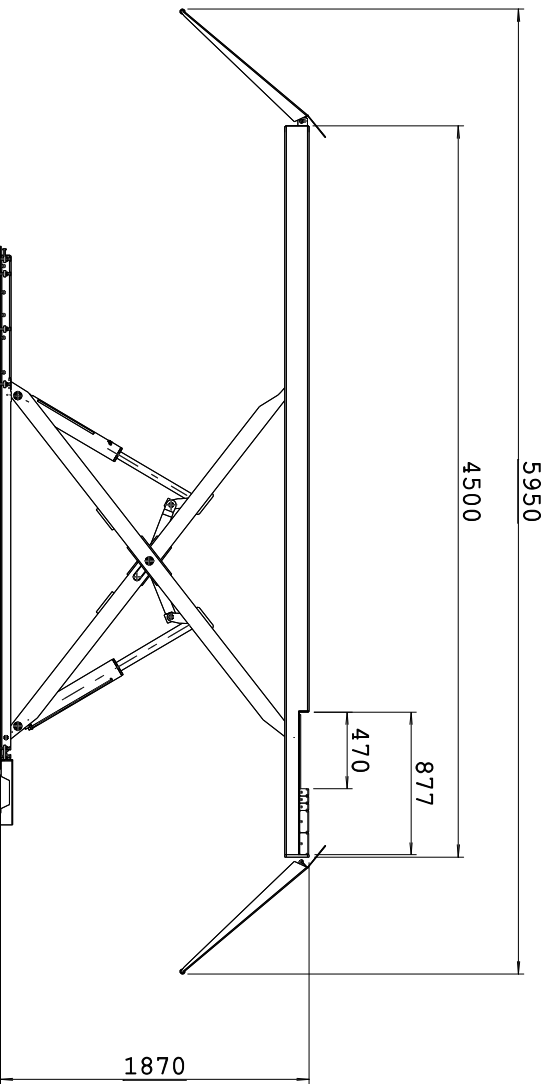

# HTC

Via degli Elettricisti - Zona Industriale  
64020 Sceme di Pineto (TE)  
Tel.: +390859463008 Fax:+390859462461  
www.htc-cnc.com e-mail: htc@htc-cnc.com

DISEGNATO F.A.	DATA 2017	REV. 2	DESCRIZIONE
CODICE COMPLESSIVO	QUANTITA' PER MACCHINA:	SCALA: 1:1	POWER LP UP45-AS 4500 SD